



CNG SYSTEM INSTALLATION MANUAL

2023-2024 FORD F-250/350 Superduty 6.8L - BI-FUEL

TABLE OF CONTENTS

IMPORTANT: Disconnect the vehicle battery before performing any installation or servicing.

- All owner information supplied by Ford must remain with the vehicle.
- Compressed natural gas is a combustible fuel, flammable and highly explosive.
- CNG is stored under pressure (3,600 psi) at 70°F (21°C).
- Tampering with or improperly maintaining the CNG fuel system can result in fatality or serious injury.
- CNG fuel system installations and system maintenance must be performed by a qualified technician.
- Exercise extreme caution and follow all related safety guidelines.
- Use appropriate tools for each process as needed. Using incorrect tools may damage the vehicle or CNG components.

Page 3	Disclaimers
Page 4	Q-222 Attaching Accessories to Aluminum Panels and Structure
Page 5-6	Preparation for Installation
Page 7- 9	Cylinder Package Installation
Page 10	Quarter Turn Valve Installation
Page 11-12	Fuel Receptacle Installation
Page 13	Fuel Fill Hose Installation
Page 14-16	Low Pressure Fuel System and Wiring Installation - Bi-Fuel
Page 17-18	Alternative Fuel Control Module Installation
Page 19-20	CNG Harnesses Diagram / Routing
Page 21	FMSS & CPS Wiring Installation
Page 22	CNG Injectors, Interceptor, TPS Wiring Installation
Page 23	MAP, AFCM, Ford Prep Wiring Installation
Page 24-25	Switch / Gauge Installation
Page 26	Low Pressure Fuel Line Installation
Page 27	Rear Wiring Harness Installation
Page 28	Coolant Hoses Installation
Page 29-30	Cylinder Cover Installation
Page 31-32	Sticker Placements
Page 33	QC, Leak Test, Final Inspection
Page 34	Contact Information

!! WARNING !! Follow instructions as directed in the installation manual and do not attempt shortcuts. Follow proper safety procedures. Failure to do so can lead to bodily harm or fatality. Tampering with or improperly maintaining the high pressure fuel system can also result in bodily harm or fatality.

!! WARNING !! Batteries normally produce explosive gas. Therefore, do not allow flames, sparks or lighted substances to come near the battery. When charging or working near a battery, always shield your face and protect your eyes. Always provide ventilation. Failure to follow these instructions may result in personal injury.

!! CAUTION !! Be aware that this installation requires the use of High Pressure, Flammable, and Highly Explosive compressed natural gas. CNG is stored under at 3,600 psi and at 70°F (21°C).

!! CAUTION !! Failure to complete the pre-installation checklist may result in severe engine damage after installation is complete.

!! CAUTION !! This installation is intended for unmodified vehicles. If the vehicle has been modified, consult Altech-Eco before the beginning install.

DISCLAIMER

Altech-Eco assumes no responsibility for damages occurring from accident, misuse, abuse, improper installation, improper operation, and lack of reasonable care or all previously stated reasons resulting in incompatibility with other manufacturer's products.

Chemicals and Lubricants

1. Silicone lubricant spray is required on all o-rings on fittings.
2. Epoxy primer or equivalent must be applied to rust proof any exposed metal.
3. Only use Ford approved coolant liquid to top off the reservoir.

THIS DOCUMENT CONTAINS PROPRIETARY DATA OF ALTECH-ECO AND SHALL NOT BE USED OR DISCLOSED IN WHOLE OR IN PART TO DESIGN OR FABRICATE ANY PRODUCT FOR ANY PURPOSE, NOR REPRODUCED OR TRANSMITTED TO ANY OTHER ORGANIZATION WITHOUT THE EXPRESS PERMISSION OF ALTECH-ECO.

This manual is subject to change at any time without notice. Contact Altech-Eco at 828-654-8300 if you are unsure of the latest version.

DISCLAIMER:

Installer assumes all responsibility for the proper installation of the System and assuring that the System is properly installed, maintained and operating in a safe condition on the Vehicle when installed. Altech-Eco disclaims liability for, or responsibility for: (a) any damages, injury, disability or death that can occur from installation errors or lack of maintenance; or (b) any consequential or special damages, including, but not limited to damages from lost profits or similar claims.

4. Insurance and Indemnification. (a) Before installing the System on any Vehicles, Installer covenants and agrees that it will at all times maintain insurance coverage with companies satisfactory to Altech covering Installer while performing installations of the System and for claims thereafter against the risks and with the minimum limits indicated below. Altech shall be named as an additional insured under the Commercial General Liability policy, without liability of premiums. The Installer shall maintain such insurance until this Agreement has been terminated.

- (i) Workers' Compensation (Applicable State Statutory Minimum Amount).
- (ii) Commercial General Liability, bodily injury and property damage combined of at least \$1,000,000.00.

To the fullest extent permitted by law, the Installer shall indemnify, defend and hold harmless Altech-Eco, its directors, officers, employees and agents from and against all claims, demands, suits, judgments, actions and liability arising out of personal or bodily injury or death of any person (including Installer's employees) or damage to or destruction of any property (including economic loss) sustained by any person or entity as a result of Installer's installation of the System on any Vehicle regardless of when such injury or damage is detected or when such death occurs, unless such injury, death, damage or loss was directly caused by the sole negligence of Altech-Eco, its officers, employees or agents. The provisions of this Section 4(b) shall survive any termination of this Agreement for a period of [10] years.

Ford QVM Bulletin: Attaching Accessories to Aluminum Panels and Structure

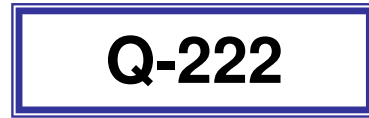

SVE BULLETIN

SPECIAL VEHICLE ENGINEERING – BODY BUILDERS ADVISORY SERVICE

E-Mail via Website: www.fleet.ford.com/truckbbas (click "Contact Us")

Toll-free: (877) 840-4338

QVM Bulletin: Q-222

Date: 22 July, 2014

Attaching Accessories to Aluminum Panels and Structure

Models Affected: 2015 MY and later F-150

Background:

The high-strength aluminum alloy in the all-new F-150 does not produce red rust like steel. We have gone to great lengths to develop coatings to inhibit corrosion. However, customers should take note that when installing aftermarket equipment, aluminum can still corrode if the aluminum is attached to dissimilar metals. This type of corrosion is called "galvanic corrosion" and it occurs where there is contact between different metals, like steel or stainless steel fasteners.

Protecting against galvanic corrosion

When installing aftermarket equipment, it is necessary that the installer pay special attention when drilling or clamping dissimilar metals to the aluminum body.

- Anytime the factory paint is damaged, it is recommended that the paint be repaired with a suitable coating prior to installing aftermarket equipment (i.e. splash guards, bug shields, tool boxes, etc.)
- When installing fasteners into the mounting hole the fastener should not have contact or have an interference fit with the sheet metal
- For zinc coated steel bolts and screws, an aluminum washer should be used
- For further protection, an isolation layer should be used between the two dissimilar metals
- When clamping onto the truck, a polypropylene or urethane tape can be used as the isolating layer

Paint, Isolator, and Fastener Recommendations

We have tested many combinations of fasteners and coatings that are widely used in the aftermarket and have provided a list of approved products to help ensure durability, strength and quality.

** For small repair of factory paints around mounting hole. Follow manufacturer's directions for use.

Approved Anti-Corrosion Coatings**

- ✓ Motorcraft PM13-A
- ✓ NOX-Rust 7703-W
- ✓ Zinc Rich Primer

Recommended Acrylic Lacquer Touch-up Paints**

- ✓ Motorcraft
- ✓ Duplicolor
- ✓ Rustoleum

Approved Fasteners

- ✓ Aluminum Clamps
- ✓ Aluminum Pop Rivets
- ✓ Zinc coated steel fasteners used with an aluminum washer
- ✓ Plastic Scrivets
- ✓ Plastic Push Pins
- ✓ Aluminum Rivnuts

Isolator Recommendations

- ✓ Aluminum washer
- ✓ Urethane tape
- ✓ Polypropylene tape

Examples

In this section we illustrate some best practices to isolate steel from coming in contact with aluminum. Using the previously listed fasteners and coatings in addition to good isolation techniques will help ensure durability, strength and quality of your F150.

Note: The following illustrations are not vehicle specific and are intended for reference only.

Figure 1 shows a plastic accessory attached to the aluminum sheet metal and the fastener properly isolated from contact with the aluminum sheet metal.

Figure 2 shows a steel accessory and steel fastener properly isolated from contact with the aluminum sheet metal.

Note: both figures show the fastener using an aluminum washer and having an oversize hole providing an air gap to the aluminum sheet metal.

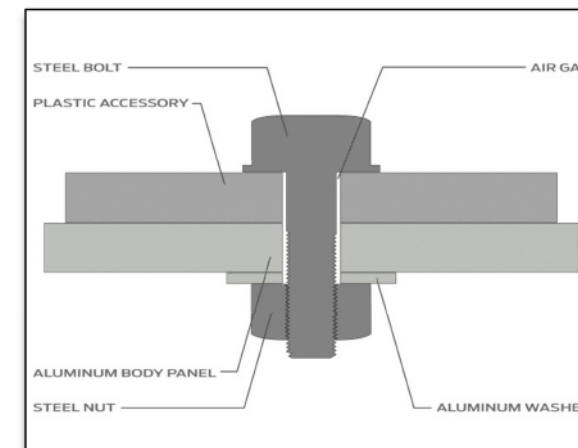

Figure 1

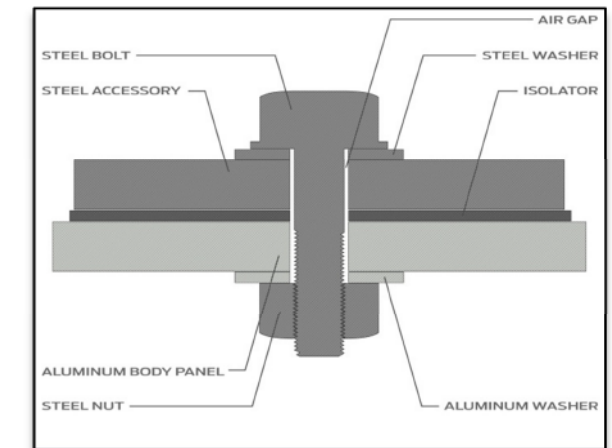

Figure 2

Important: Fasteners or coatings that should be avoided

The items listed below can accelerate galvanic corrosion in aluminum and should be avoided. If a steel fastener must be used it is necessary to properly isolate from contact with the aluminum.

- ✗ self-tapping screws
- ✗ steel pop rivets
- ✗ steel rivnut
- ✗ steel spring clips
- ✗ RTV silicone
- ✗ stainless steel fastener

If you have any questions, please contact the Ford Truck Body Builders Advisory Service as shown in the header of this bulletin.

PREPARATION FOR INSTALLATION

Have the Ford factory vehicle manual available for additional instructions necessary during the system installation.

STEP 1: Depressurize the gasoline fuel system (FPCM)

1. Disconnect the (FPCM) Fuel Pump Control Module electrical connector.
(A) Chassis - located on the frame crossmember near gasoline tank or towards front cab passenger side.
(B) Pickup - located passenger side inside the framerail between cab and rear tire.
2. Crank the engine and allow it to idle until it stalls and engine shuts off.
3. After the engine shuts off, crank the engine for approximately 5 seconds to make sure that the fuel rail pressure has been released.

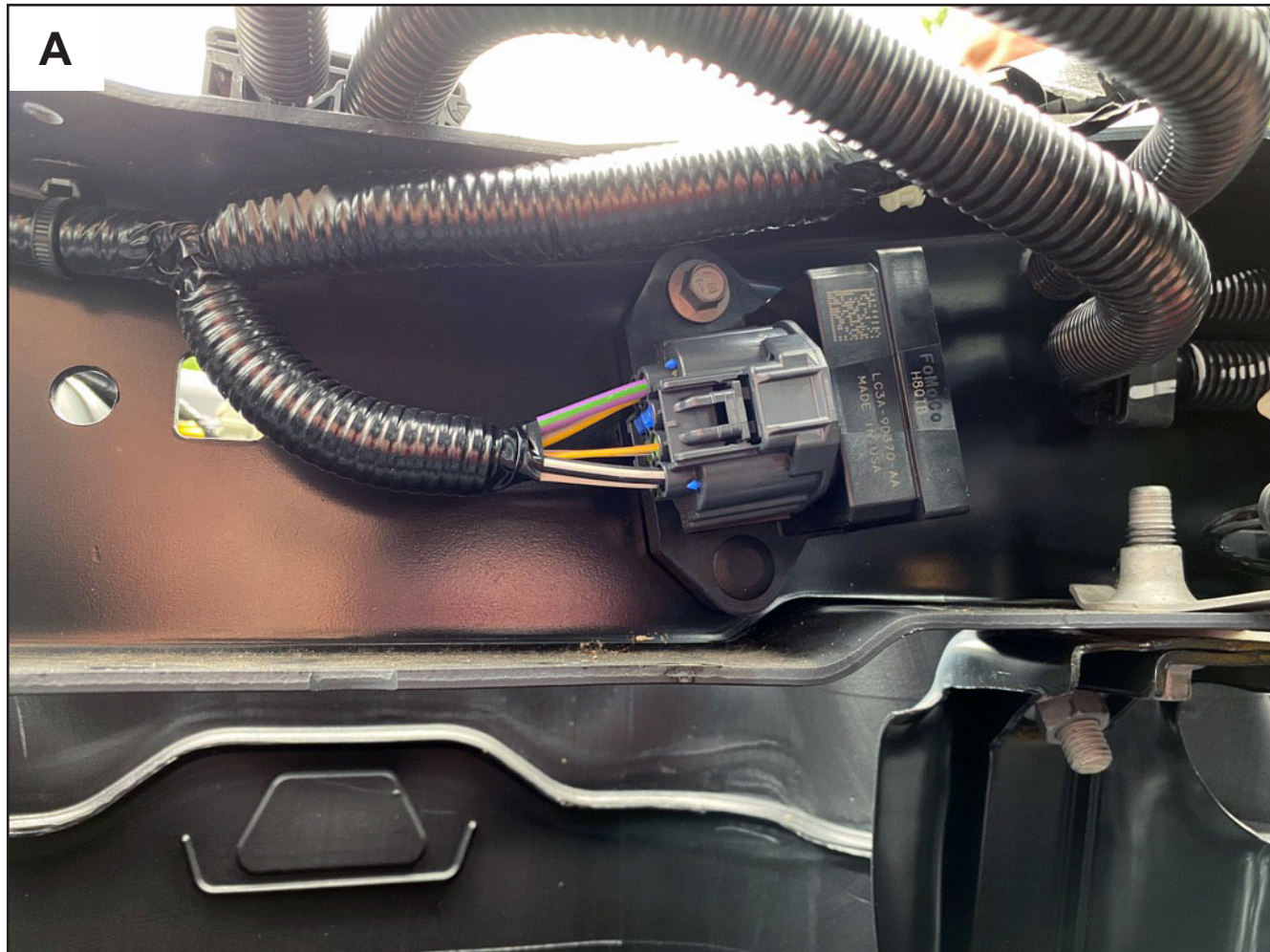

PREPARATION FOR INSTALLATION

STEP 2: Disconnect the negative terminal from the vehicle battery and place a plastic cap on terminal to protect from accidental contact. Battery is to stay disconnected until CNG system installation is completed. Vehicle battery must be reconnected to be able to perform a leak test, tank valve operation, etc...

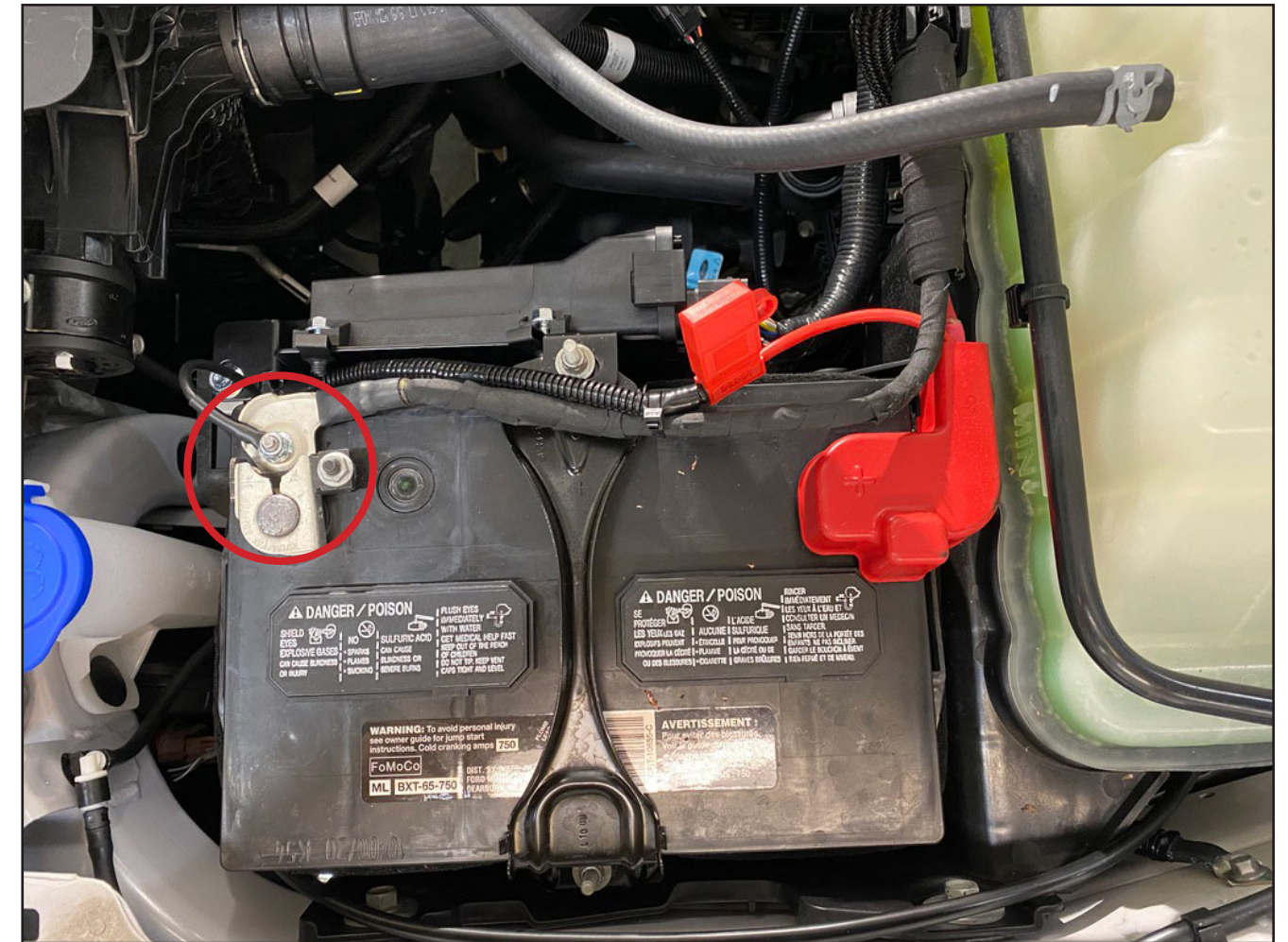
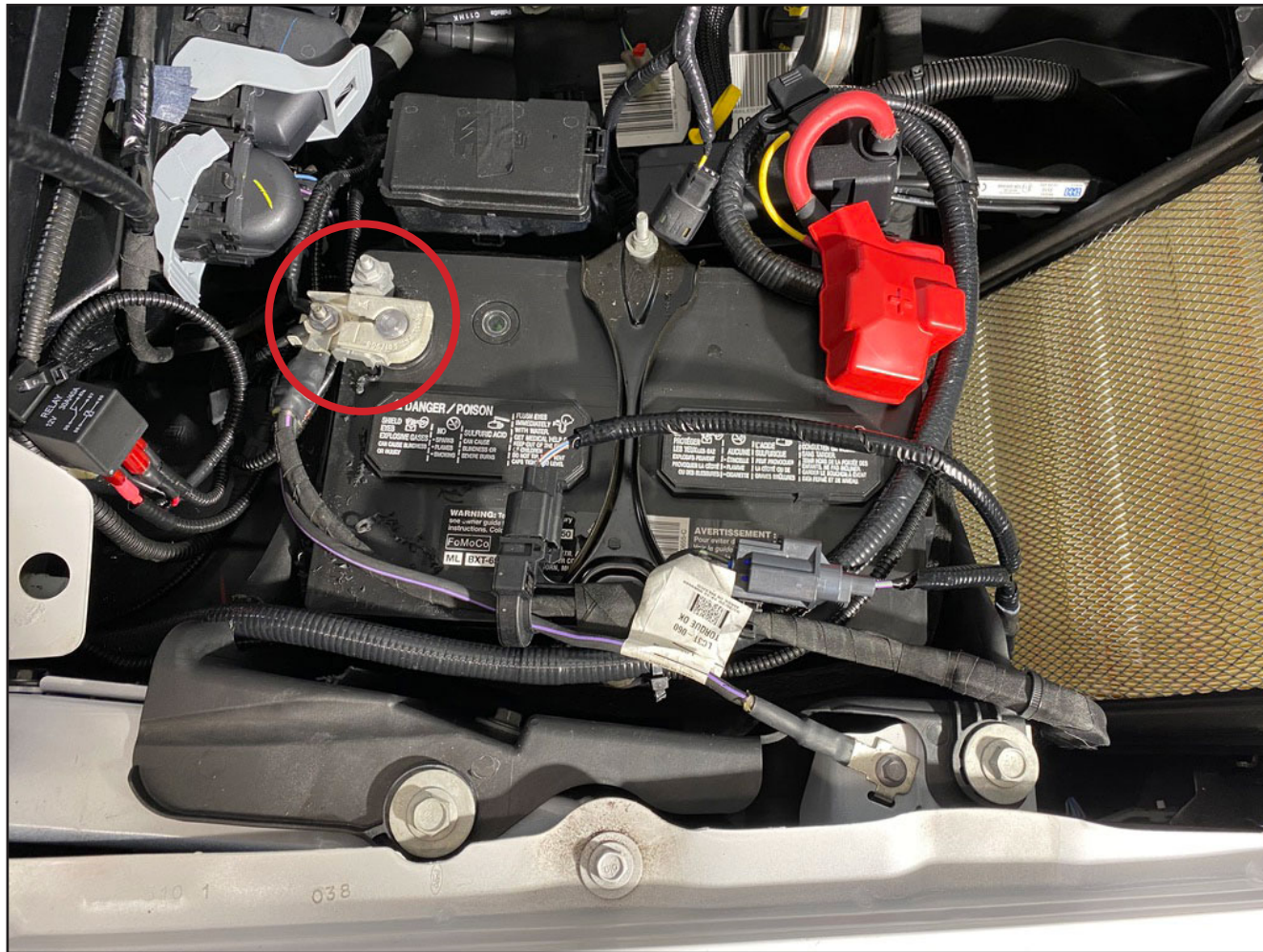

21" x 60" CYLINDER DRILL TEMPLATE - 8' LONG BED

IMPORTANT:

Always call Altech-Eco to verify you have latest template. Subject to change without notice.

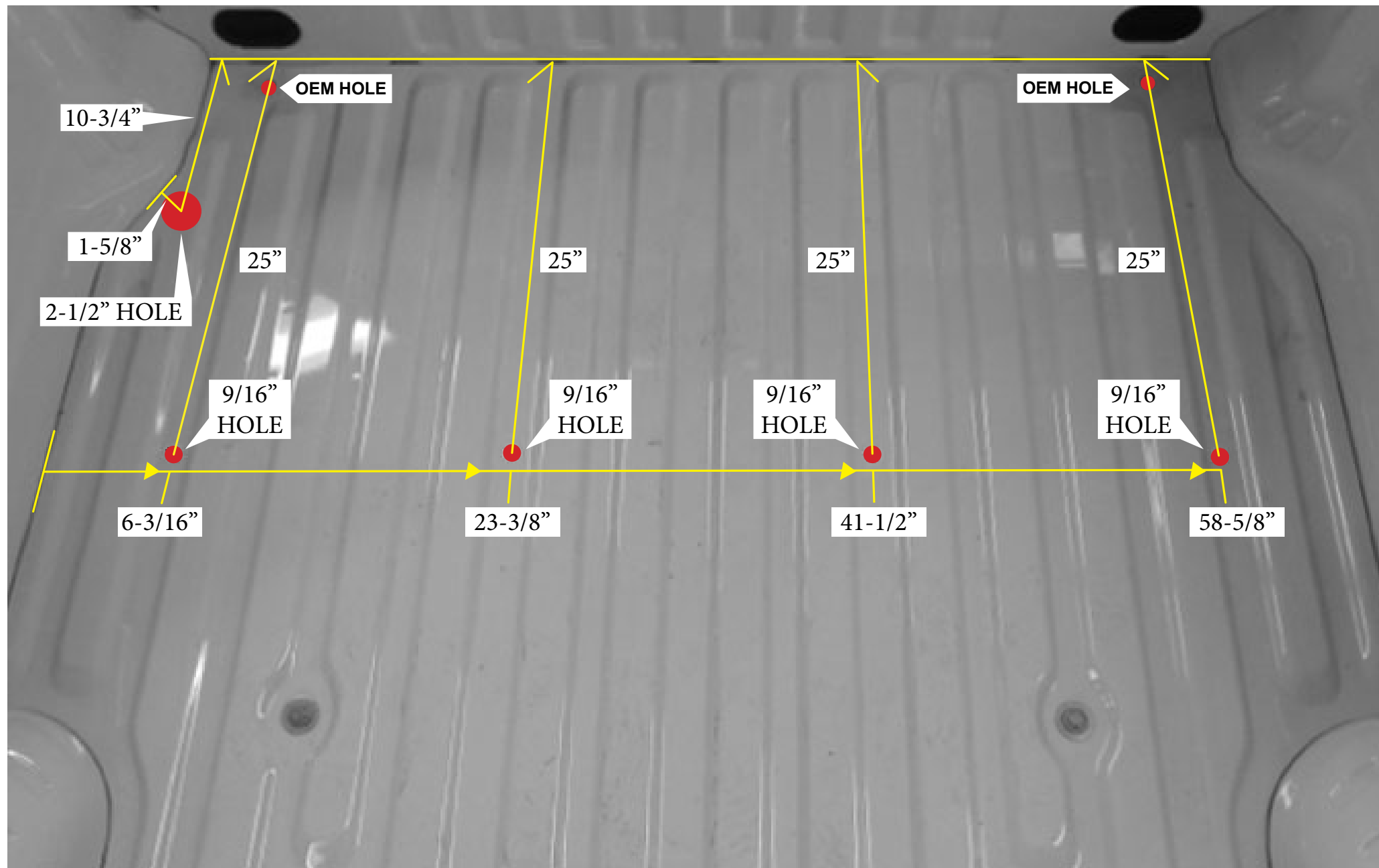

Drill 2-1/2" grommet hole in center corner island.
Drill 9/16" holes in center between ribs

Updated: 8-12-20

17-20-6.2-DRILLTEMP-21x60

CYLINDER INSTALLATION - 8' LONG BED

1. Remove two front OEM bolts from bed and discard.
2. Drill hole for grommet using the drill template. Fit 2 1/8" grommet in place.
3. Drill holes for cylinder bed mounting plates. Lay cylinder bed mounting plates in bed prior to drilling holes. Place the cylinder package in bed over holes drilled.
4. Secure front bracket with two M12-2.0 x 120mm bolts and 1/2" washers (4a/b). Torque each bolt to 75 ft-lbs.
5. Secure rear bracket (closest to tailgate) with four 1/2"-13 x 2" bolts, 1/2 washers and nuts, and backing plates underneath, thread facing up (5a/b). Torque each bolt to 75 ft-lbs.
6. Gather provided pre-bent vent tube and align to determine where to drill the vent tube 7/8" hole in bed. Drill 7/8" hole and install the grommet, apply silicon to grommet and slide vent tube through grommet. Secure and tighten all fittings.



2 1/8" grommet.

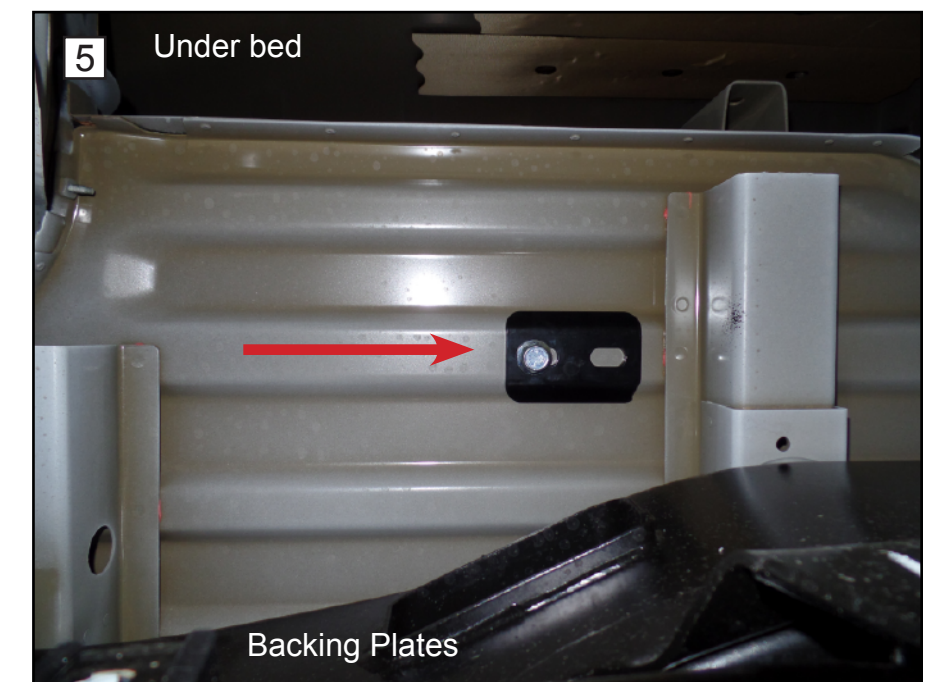
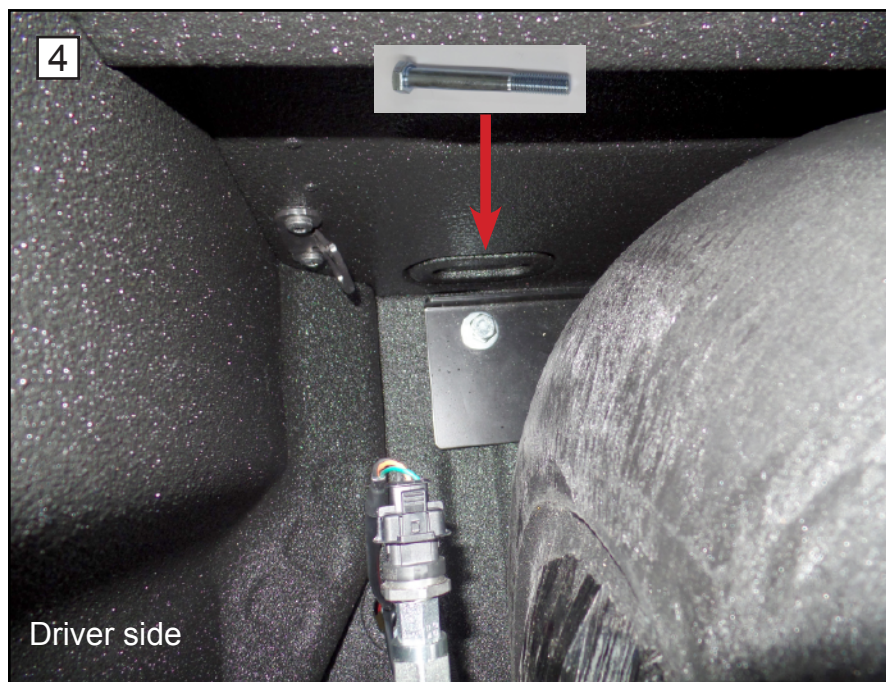
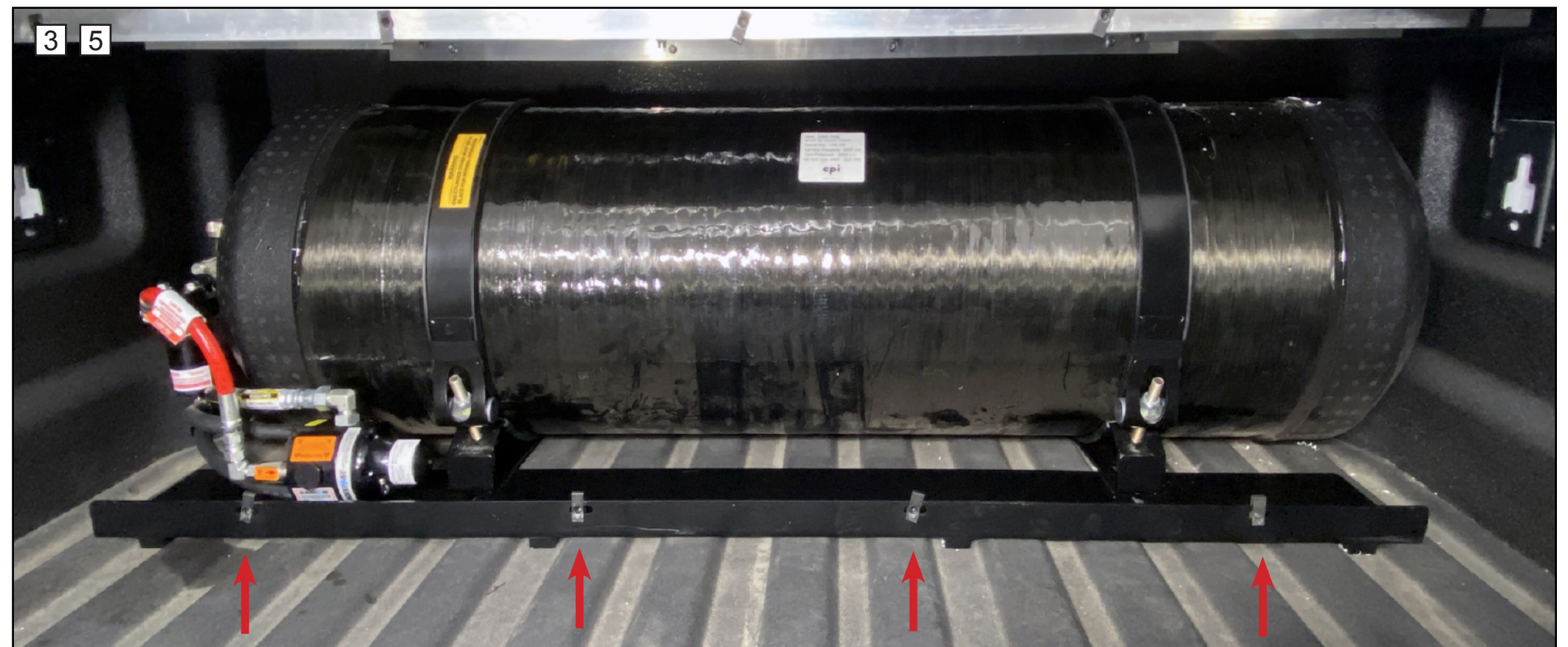
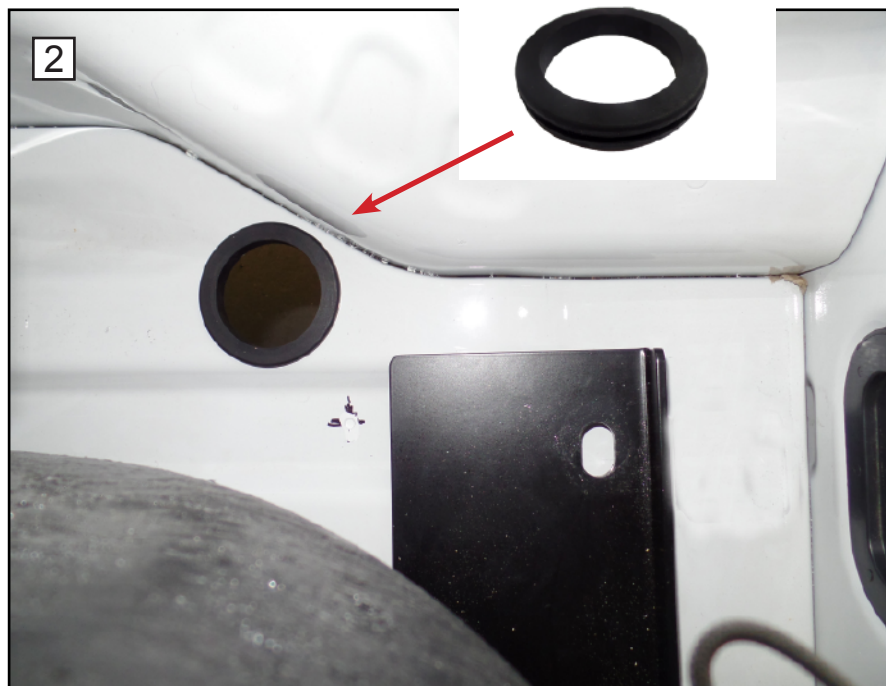

CYLINDER INSTALLATION - FUEL & COOLANT LINES

Upon wiring and hose routing completion, connect each end to the cylinder package accordingly.

- Connect low pressure fuel line to the regulator once it is routed. Torque to 30-35 ft-lbs.
- Connect rear wire harness to the high pressure sensor located at the cylinder valve.
- Connect coolant hoses to the regulator once hoses are routed. Secure with coolant hose clamps.

Note: Once low pressure hose, rear harness, and coolant hoses have been routed through grommet, zip tie all together near grommet to eliminate any slack or potential abrasion.



High pressure hose from fuel fill receptacle.

CNG Coalescing Fuel Filter Housing.

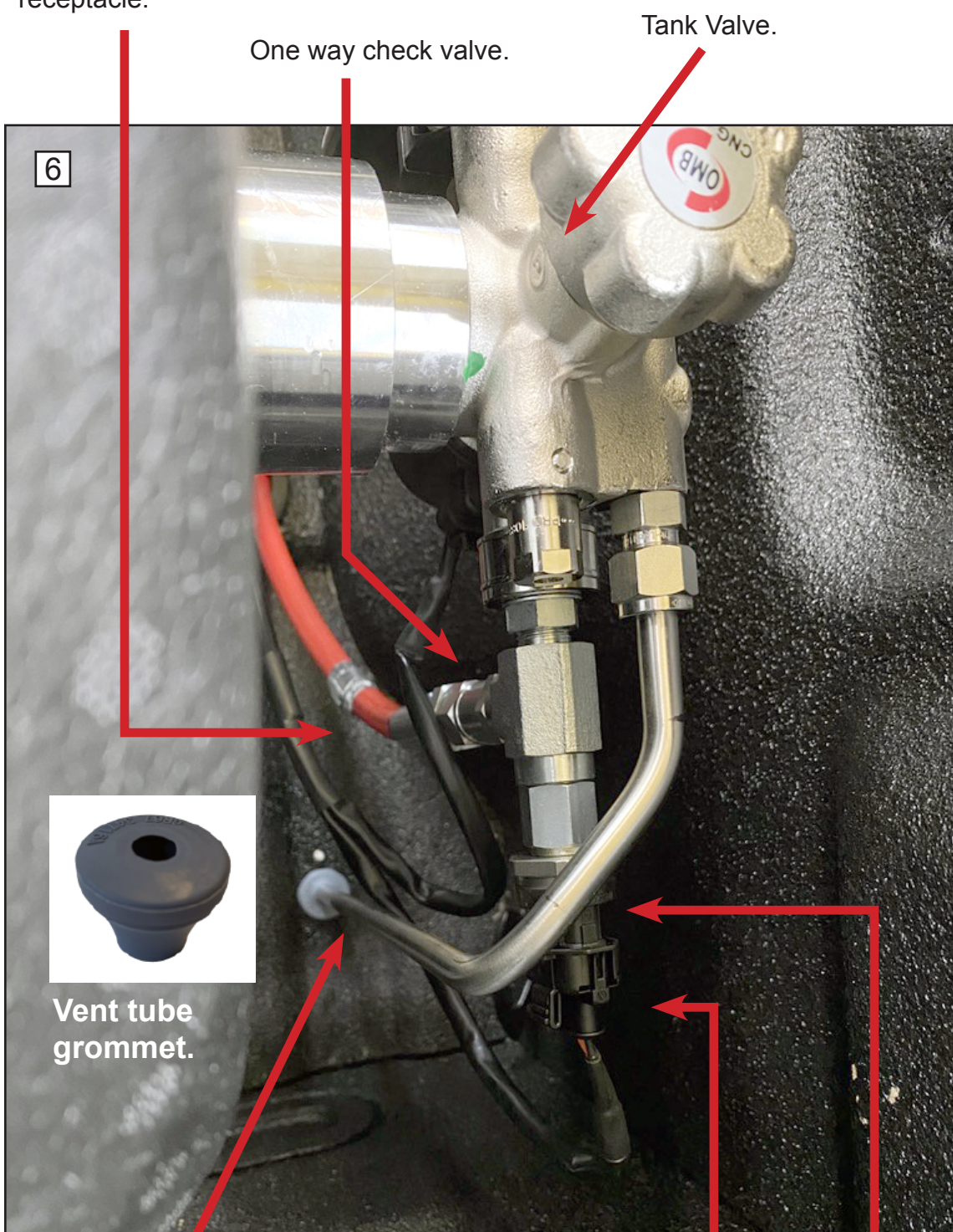

High pressure hose from tank.

Low pressure hose.

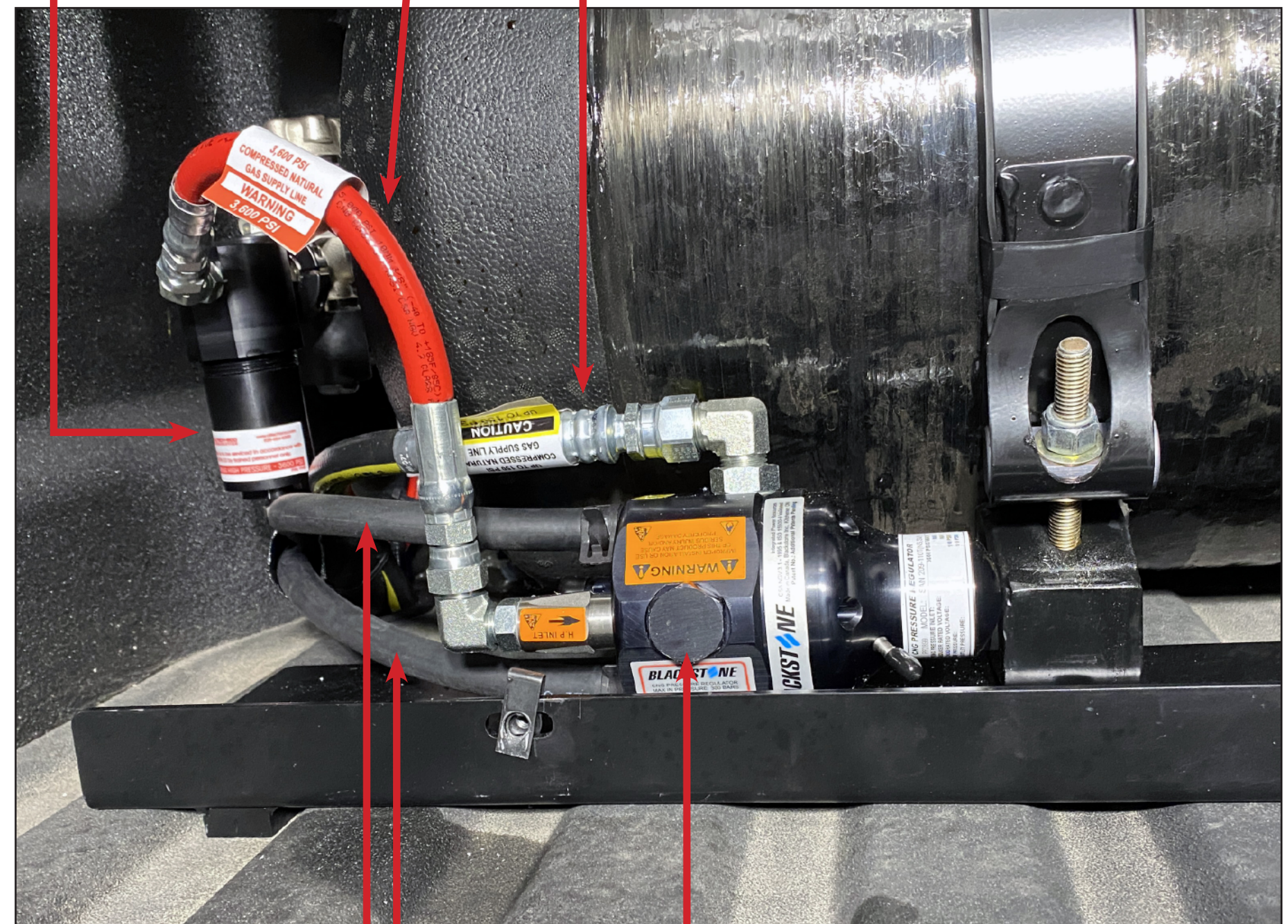

Two coolant hose connections.

High to low pressure regulator.

6

One way check valve.

Tank Valve.



Vent tube grommet.

Vent tube and grommet.

Rear wire harness connection.

High pressure sensor.

QUARTER TURN VALVE INSTALLATION

1. Quarter turn valve is to be installed under vehicle on drivers side. Location of valve in photo.
2. Retrieve the quarter valve assembly and place on double layered metal and slide against frame rail.
3. Once in position, using the hole on bracket closest to the handle on valve mark the location to drill the hole.
4. Drill an 1/4" hole on marked location.
5. Retrieve the assembly and secure in position using an 5/16 -18 -3/4" self cutting screw. Torque to 20 ft-lbs
6. Connect low pressure hoses to each appropriate ends. Torque to 30-35 ft-lbs.

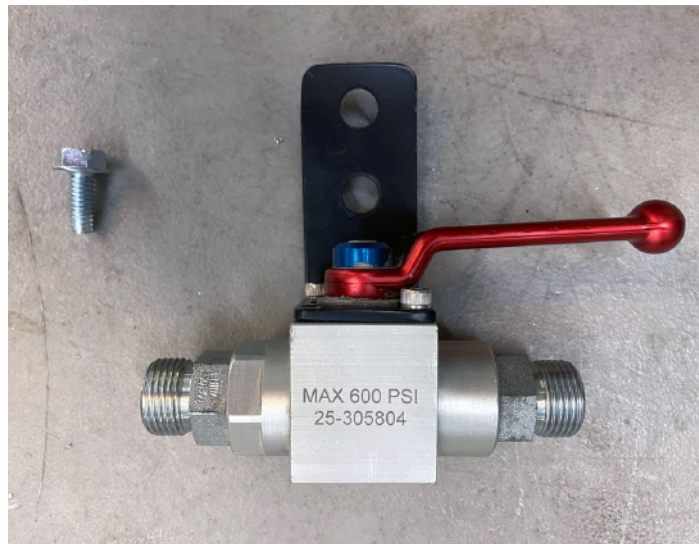

FUEL RECEPTACLE INSTALLATION

1. Remove OEM gasoline fuel cap.
2. Remove the plastic cover.
3. Remove screws that hold fuel tank breather tube assembly. Discard OEM screws.
4. Underneath, use a 1/2" p-clamp and a self tapping screw to secure breather tube assembly to the side as illustrated in picture (D/E).
5. Enlarge the that held breather tube assembly (E) holes to 5/16".

Enlarge holes. Deburr and rust proof.

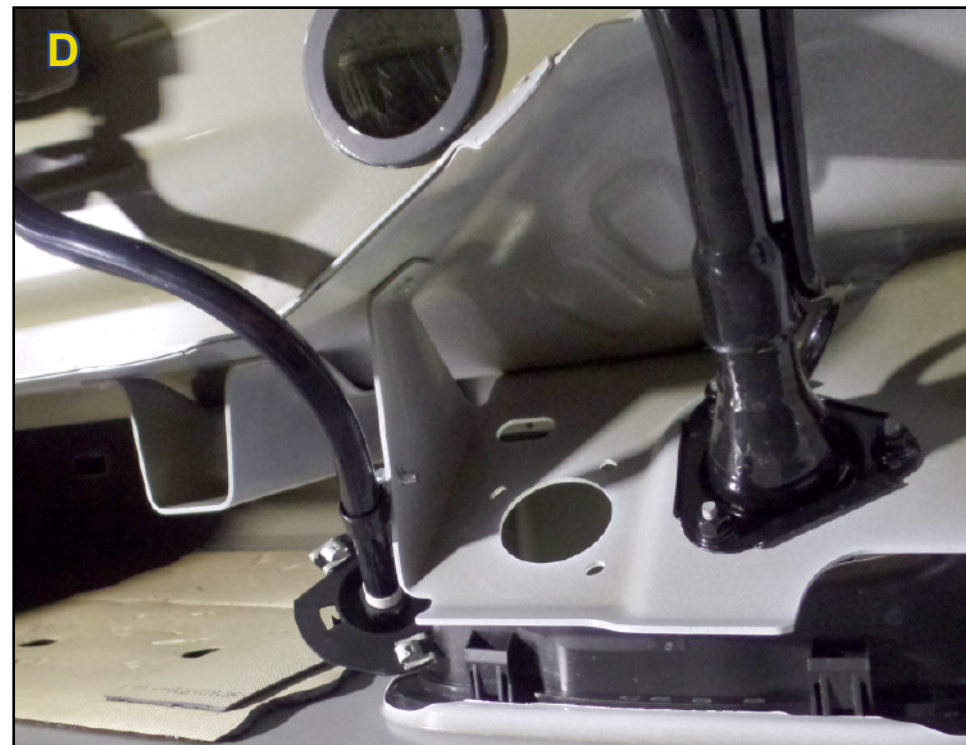
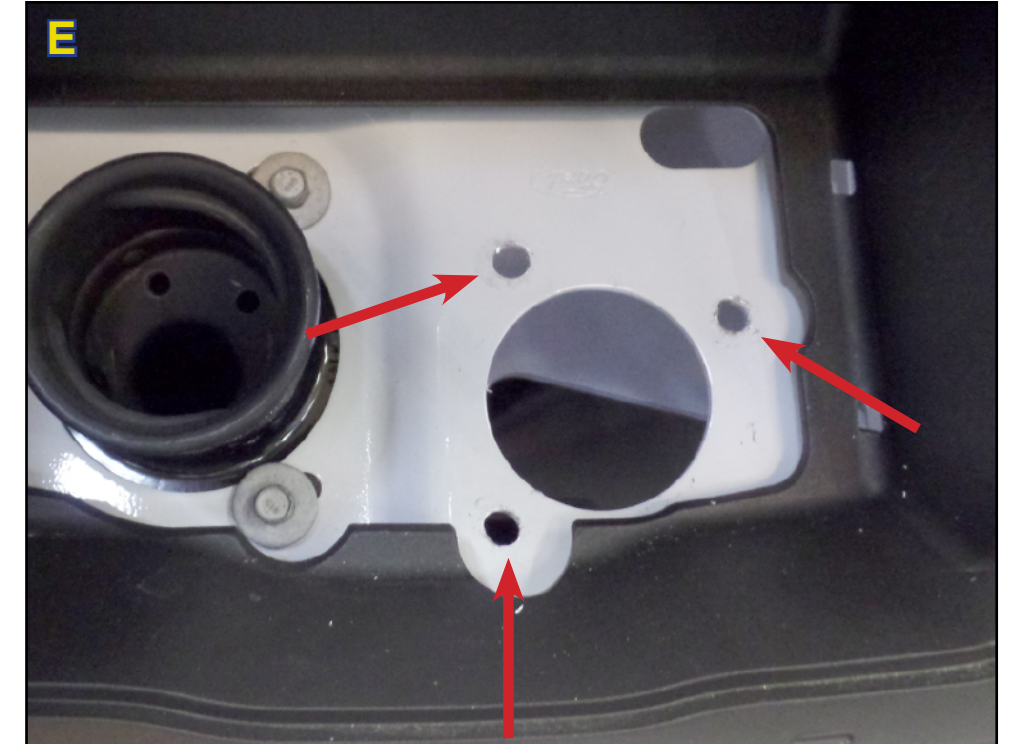

FUEL RECEPTACLE INSTALLATION

6. Assemble fuel fill receptacle (F-G).
7. Place u-nuts into each hole location (H).
8. Position receptacle assembly into fuel tank breather location and secure with three 1/4" bolts (I).
9. Place rubber dust cap over the receptacle (J)
10. Remove E85 text from gas cap (K). This vehicle can no longer use E85.

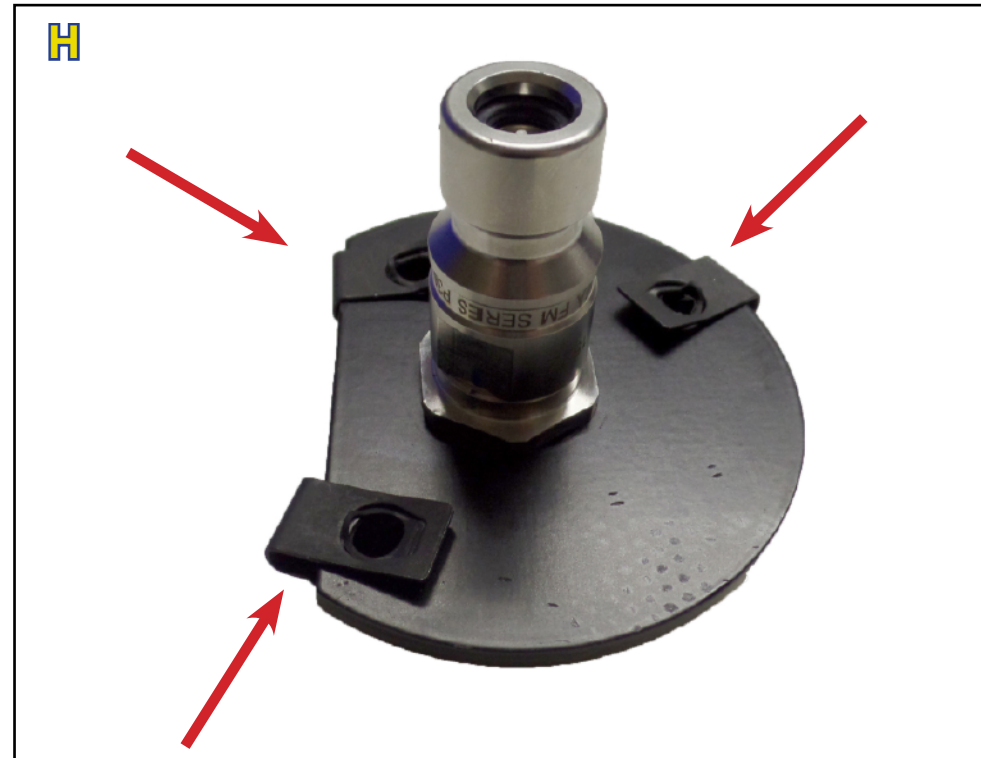
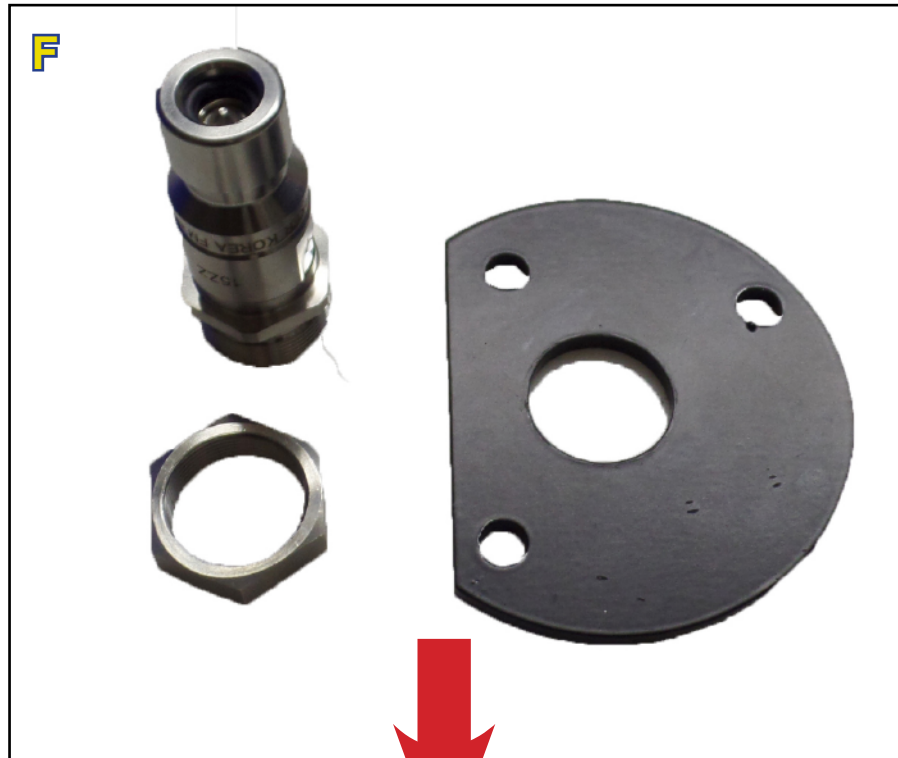

FUEL FILL HOSE INSTALLATION

1. Connect 45 degree fitting to the receptacle. Angle properly and tighten. Torque to 30-35 ft-lbs.
2. From underneath feed the provided high pressure hose through grommet hole up and into the bed.
3. Connect end of the hose to the one way check valve located on the cylinder package. Torque to 30-35 ft-lbs.
4. Connect the other end of hose to 45 degree fitting at receptacle. Torque to 30-35 ft-lbs.

Note: Upon completion, ensure high pressure hose is labeled with a high pressure warning sticker.

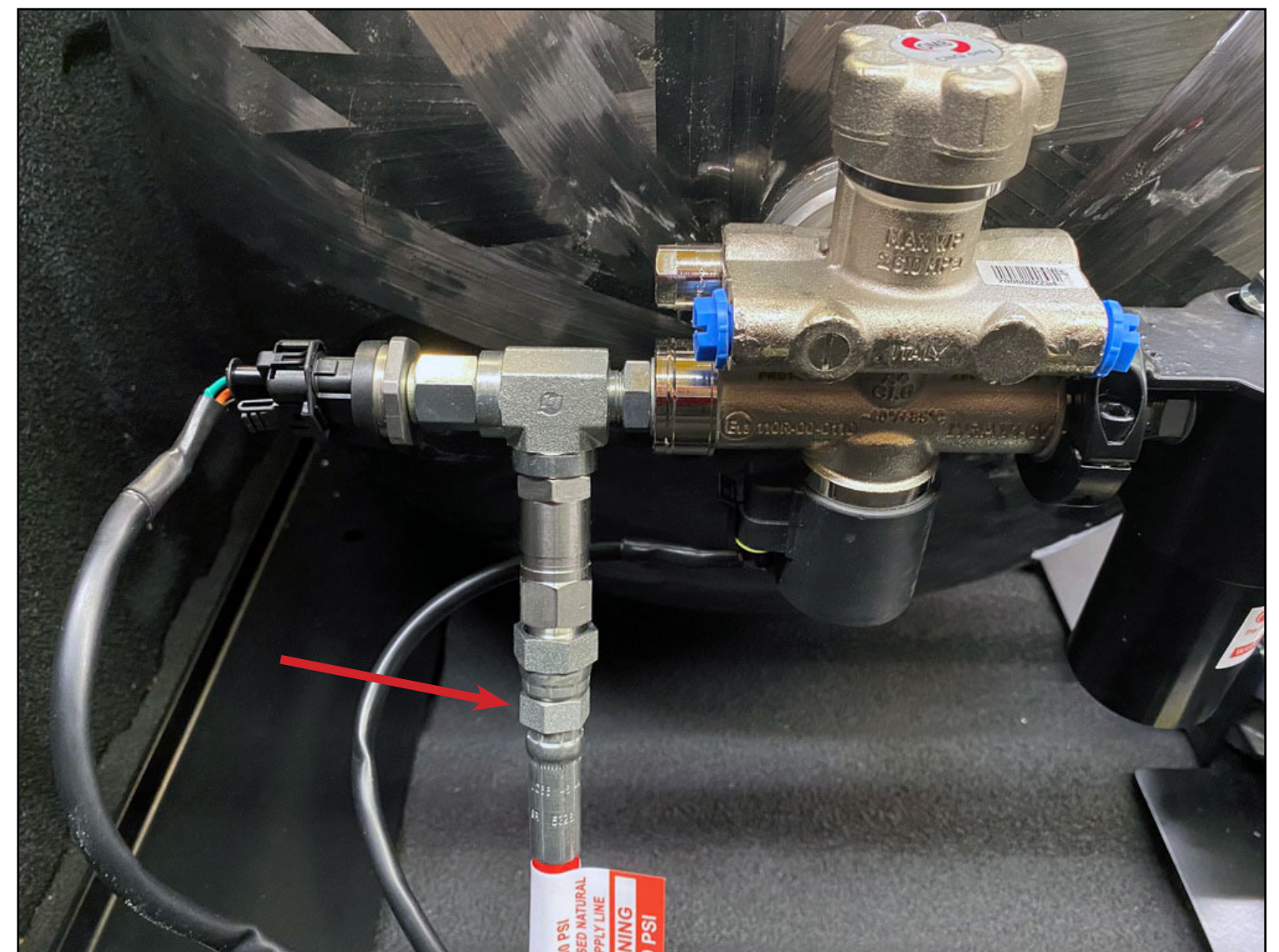
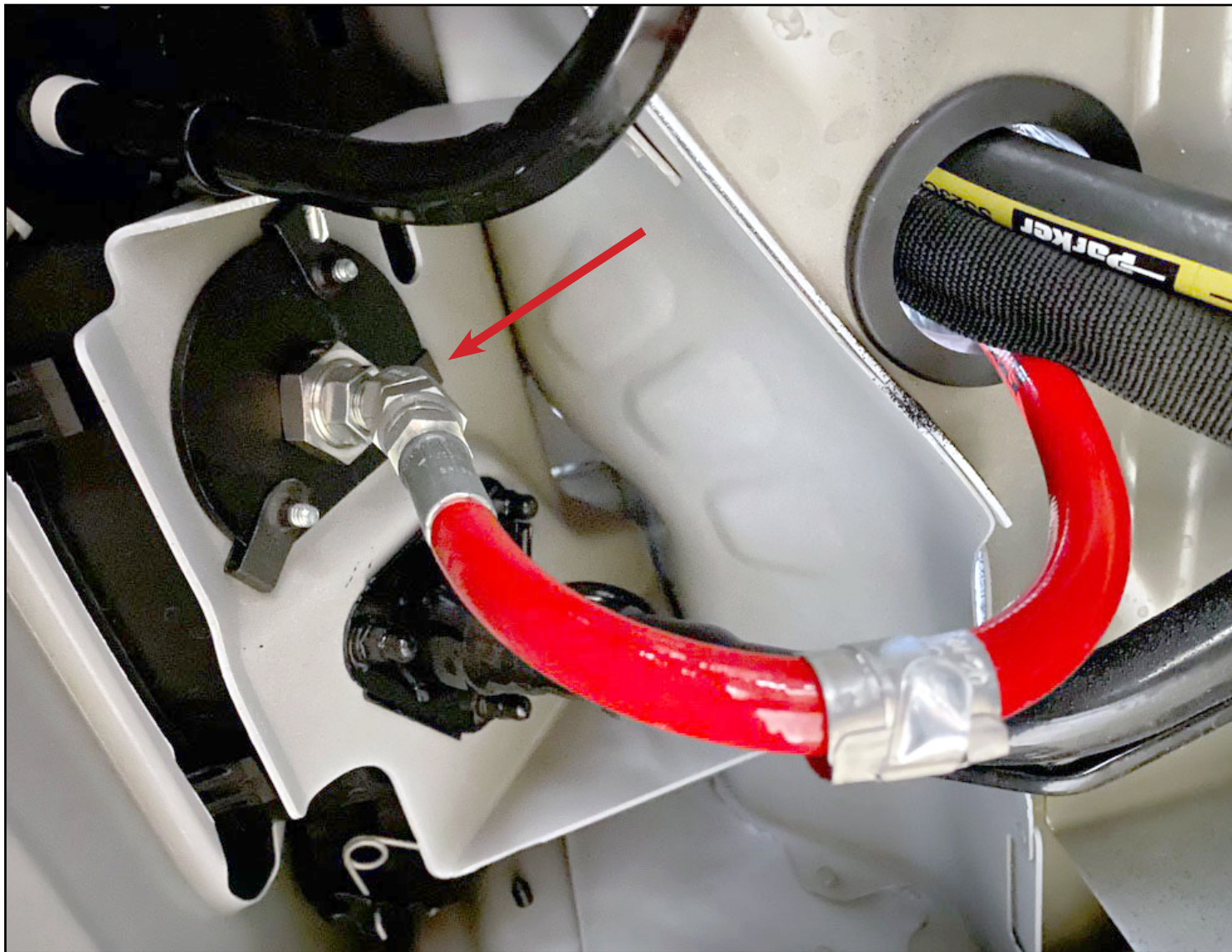

LOW PRESSURE FUEL SYSTEM AND WIRING INSTALLATION - BI-FUEL

1. Remove the air box and disconnect all connections to the air box and set to the side.
2. Disconnect two hoses and set to the side. One is on driver side and one is on passenger side of engine.
3. Disconnect all 8 gasoline injector connectors and 8 coil connectors.
4. Remove 4 gasoline fuel rail 10mm bolts. Two bolts per fuel rail. One fuel rail on driver side and one fuel rail is on passenger side of engine.
5. Apply Silicone on the hose clamp that is attached to intake manifold. It is the clamp holding the gasoline fuel rail hose crossing over engine and attached to intake manifold. The silicon allows the hose to move side to side freely. This makes it easier when needing to move the gasoline fuel rails (still attached to this hose) out of the way to install or remove other parts.
6. Pull out both gasoline fuel rails with the gasoline injectors still attached from each side of engine. Do not disconnect gasoline injectors from fuel rail or they will leak gasoline.
7. Gather the 8 CNG injector adapters supplied with kit, apply silicone to each rubber o-ring, and insert into 8 open engine injector ports. Be sure they are pushed in all the way and seated properly.

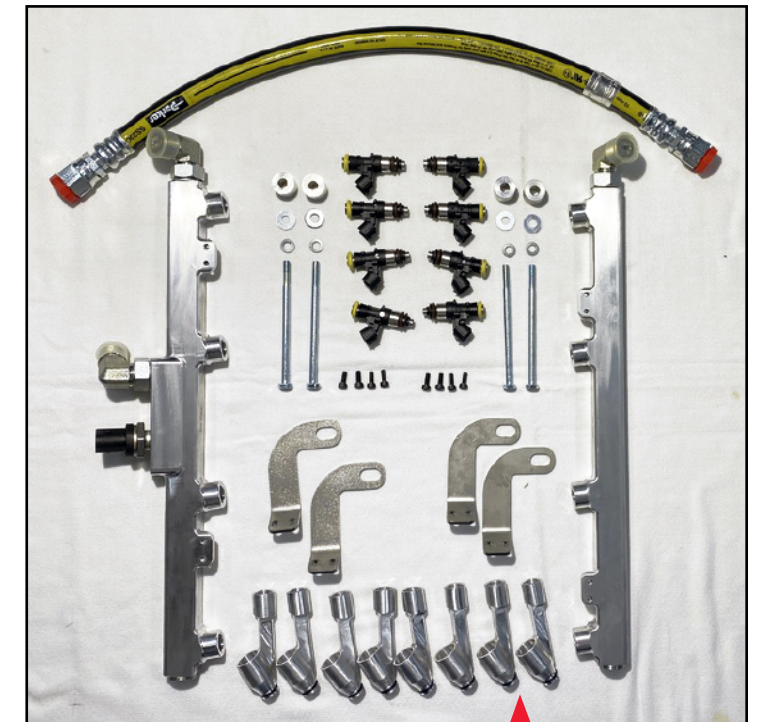
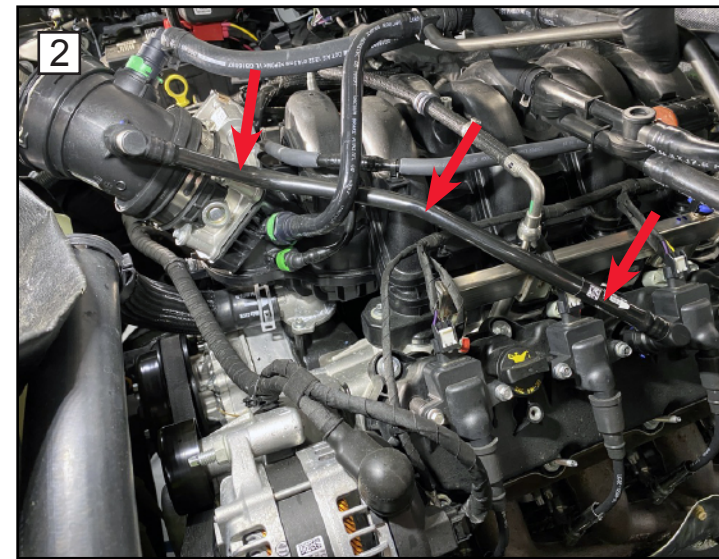
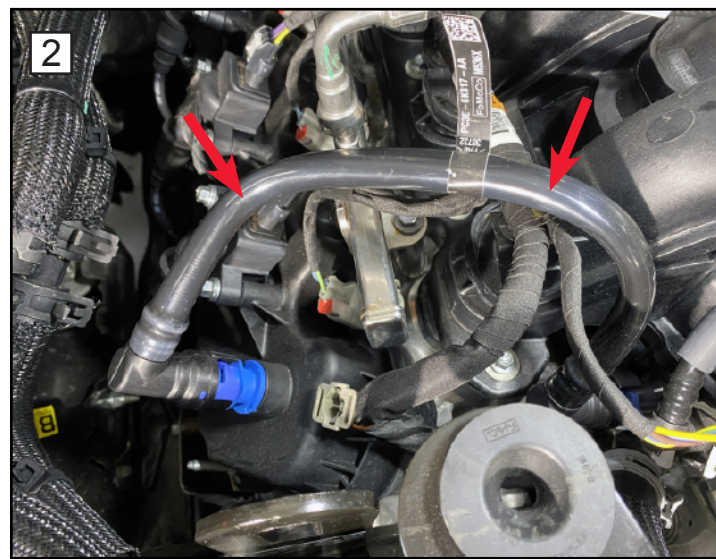

CNG injector adapters ↑

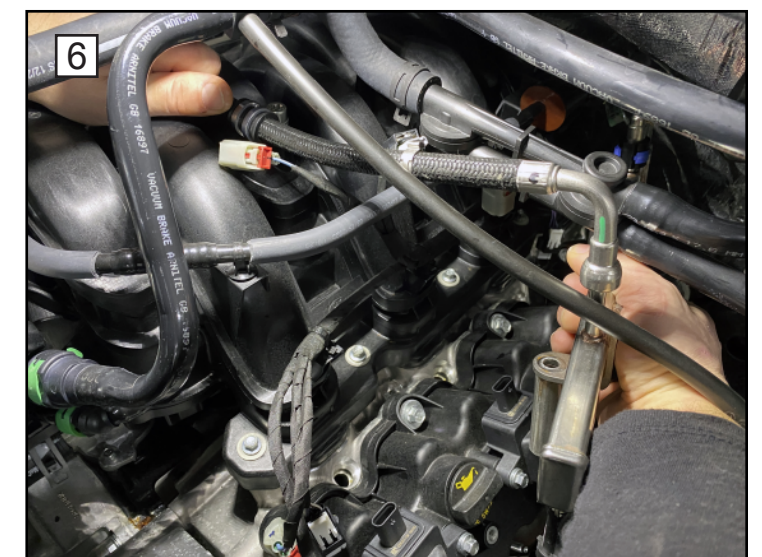
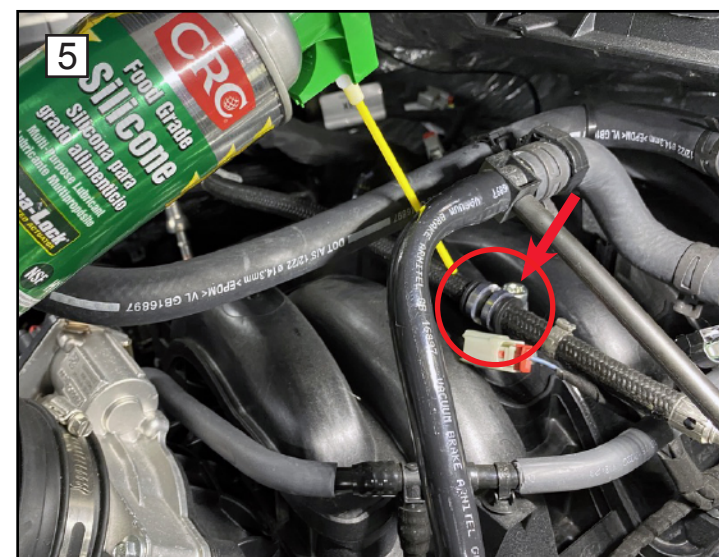
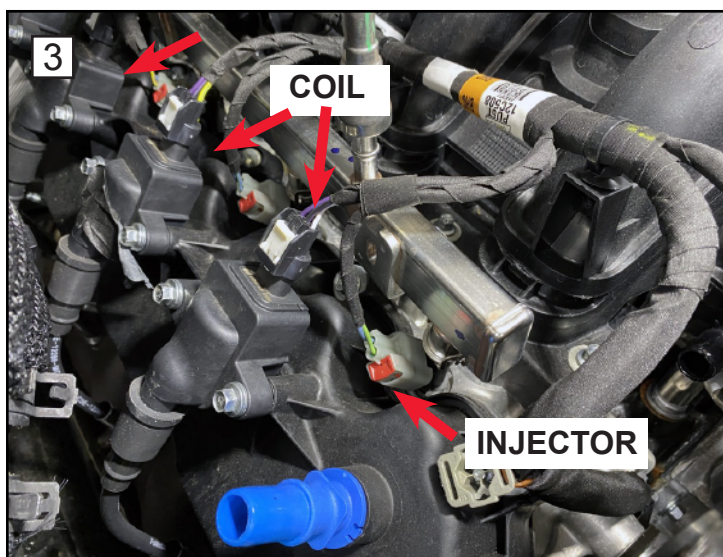

LOW PRESSURE FUEL SYSTEM AND WIRING INSTALLATION - BI-FUEL - CONT.

8. Gather parts and assemble the CNG Fuel Rail Assembly. 2 CNG fuel rails, 4 support brackets, 8 small black bolts and 8 CNG injectors. There are 2 CNG fuel rail assemblies. Each fuel rail has a part number engraved on it that identifies where it is to be installed. Apply silicon to injector o-rings and insert into fuel rails. Attach two brackets to each fuel rail with small black bolts, only hand tighten these 2 bolts for now, you will need to be able to move the brackets into proper position before tightening completely. See Picture No. 8 for reference.
 - PART # **FR6.8-D** (Driver Side CNG Fuel Rail)
 - PART # **FR6.8-P** (Passenger Side CNG Fuel Rail)
9. At this point, pick a side of engine to install the fuel rail assembly. Repeat for other side once complete.
10. Gather 2 spacers provided and place in position where you removed the 2 gasoline fuel rail bolts earlier.
11. Gather appropriate CNG fuel assembly, apply silicon to injector or-rings and place into position with CNG and gasoline injectors inserted into CNG adapters (Do not push in all the way, you need movement to get things aligned). All CNG injector connection ends should be facing towards center line of the engine.
12. Gather 1 provided gasoline bank interceptor wire harness and connect harness to 4 gasoline injectors and 4 gasoline harness connectors. Connector at end will be towards front of engine.
13. Reconnect 4 gasoline coil connectors.
14. Gather 2 provided 4" 10mm bolts, 2 washers, and 2 lock washers. Insert both bolts with washers through fuel rail support brackets and through spacers into engine. Hand tighten, do not use power tools at first because you may strip out threads.

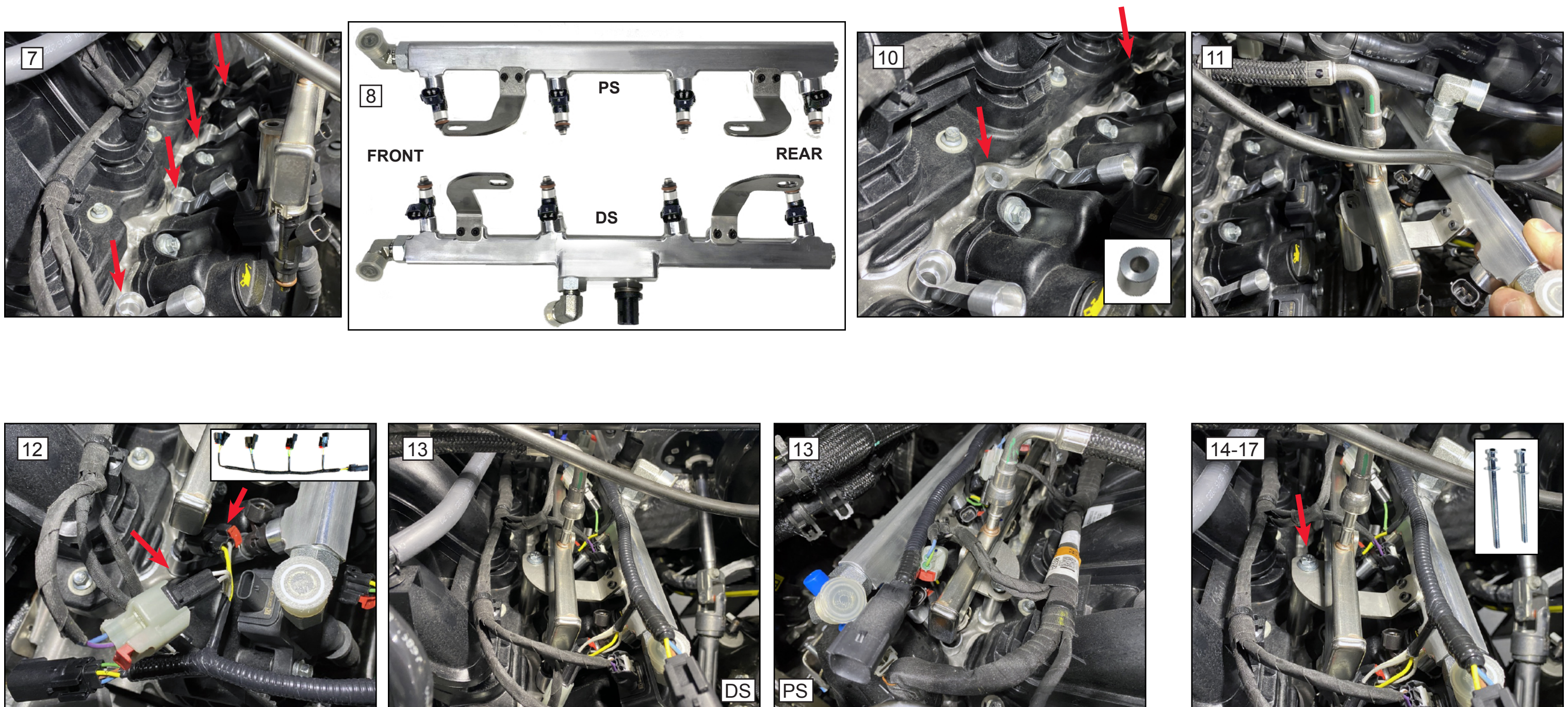

LOW PRESSURE FUEL SYSTEM AND WIRING INSTALLATION - BI-FUEL - CONT.

15. Now that the fuel rails assembly is in position go ahead and push down on rails assembly and seat injectors into the CNG adapters.
 16. Now Tighten both of the 4" 10mm fuel rail bolts. Torque bolts to 89 lb.in (10 Nm).
 17. Make sure everything is seated and snug, then tighten all 4 of the small black bolts (3 mm allen) that secure the CNG fuel rail to the support bracket.
- Go back to Step 9 and repeat steps 9-17 for other side fuel rails assembly.
18. Position main CNG wire harness on top of engine and connect to CNG injectors, interceptor harness, CNG Fuel Rail Sensor. Install the harness along same route as original Ford wire harnesses when possible. (See main CNG wire harness install section for details). Use zip ties as needed and make sure there are no loose or hanging wires.
 19. Gather the provided 24" CNG low pressure flexible hose and connect the driver side and passenger side CNG fuel rails together. Adjust 90° fittings as needed, position hose over throttle body and tighten ends of the hose and all fittings. Torque to 30-35 ft-lbs.
 20. Connect the CNG low pressure flexible hose that has been previously routed from quarter turn manual shut-off valve into the engine compartment. Tighten end of the hose and all fittings. Torque to 30-35 ft-lbs. Make sure the low pressure supply hose is not touching other parts (ex. metal, brake lines, bolts, etc.). If touching other parts it will create wear over time and will fail. Zip tie as needed.
 21. Reinstall and reconnect the air box and both OEM vacuum hoses and wiring.
- IMPORTANT** - Zip tie all wires to original Ford wire harnesses with zip ties where possible. There is to be no loose or hanging wires. Wires and hoses are not to be touching any surfaces that may cause cutting, abrasion or deterioration from rubbing or vibrations.

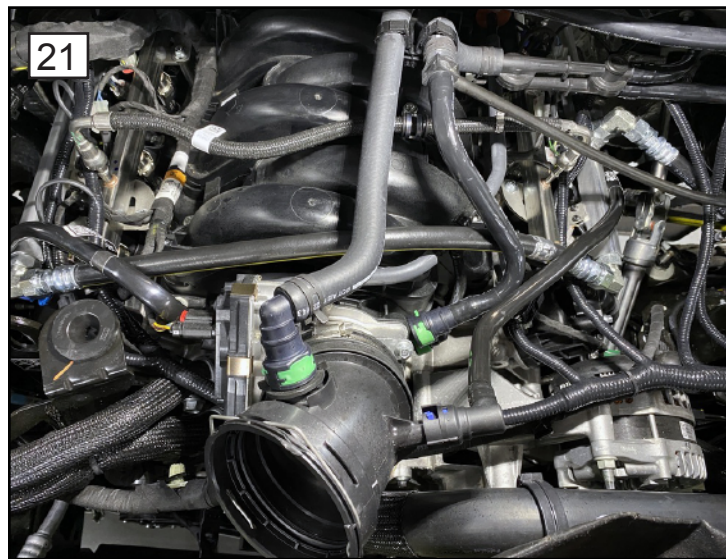
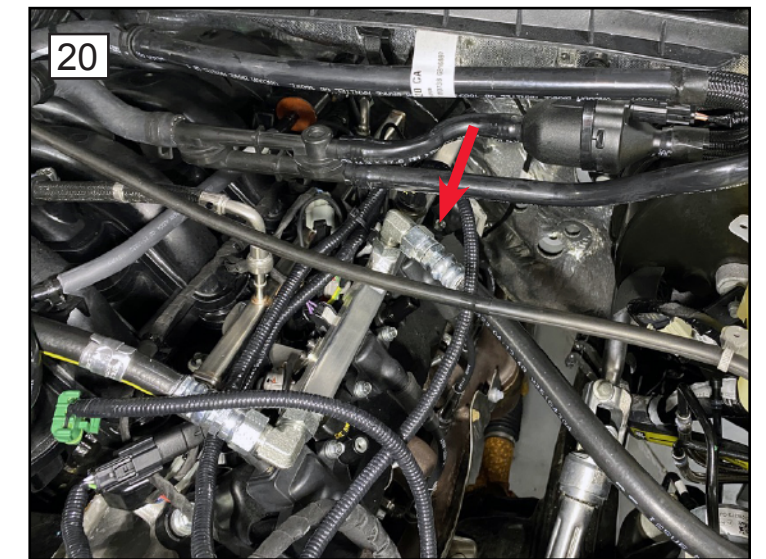
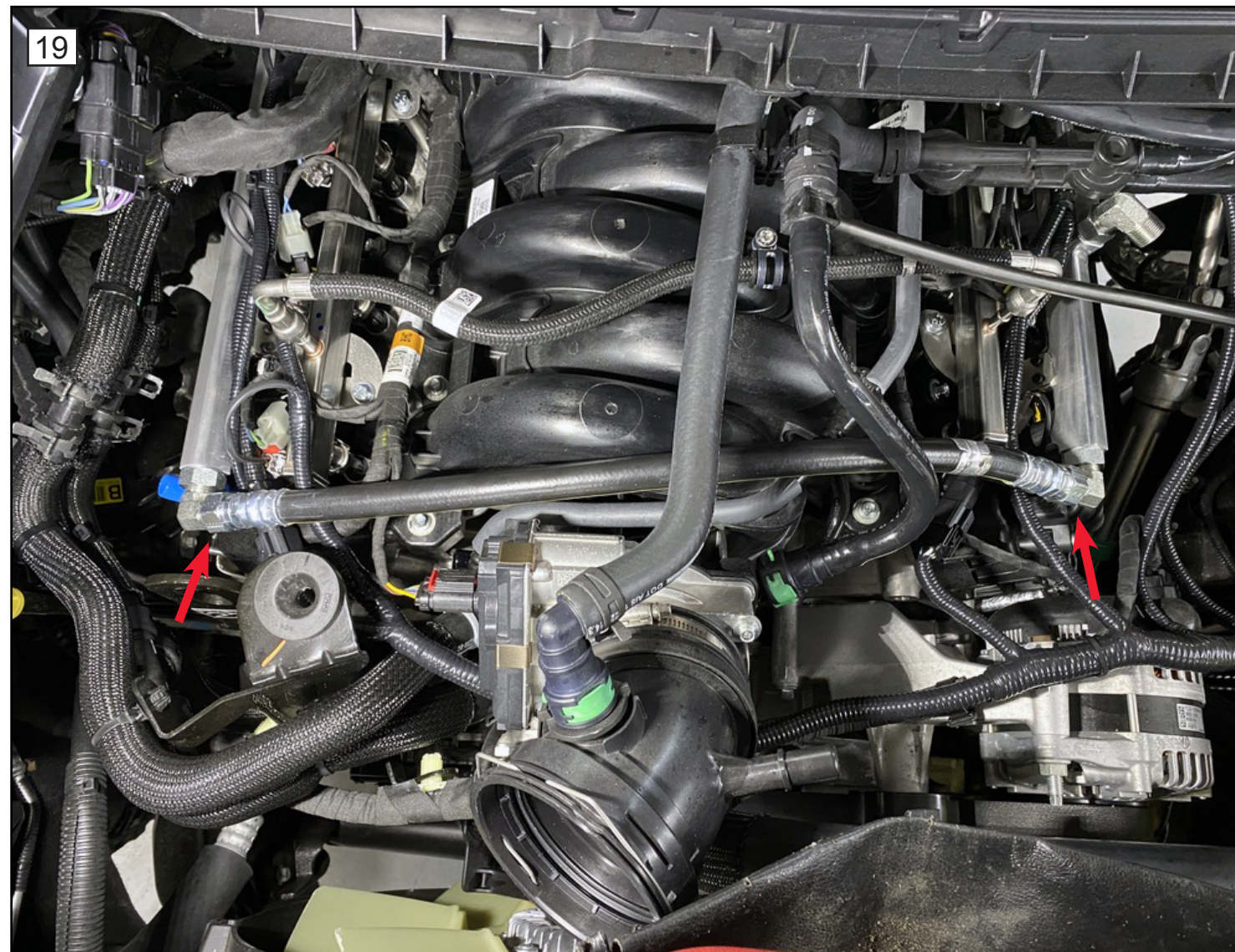

ALTERNATIVE FUEL CONTROL MODULE INSTALLATION (SINGLE BATTERY)

Single Battery AFCM Installation:

1. Remove OEM bolt (pic. A) and save for reuse.
2. Position AFCM Bracket in place and use it as a template to mark the drill location for bottom slotted hole (pic. B).
3. Drill an $25/64$ " hole. Deburr and rust proof.
4. Install the 1/4-20 (RN2520165LR) rivet nut.
5. Position AFCM bracket and secure the top with original Ford bolt and bottom with a 1/4" bolt.
6. Attach the four provided u-nuts to bracket.
2. Position AFCM on bracket and attach with four provided 1/4" bolts.
3. Connect the main CNG harness to the AFCM.

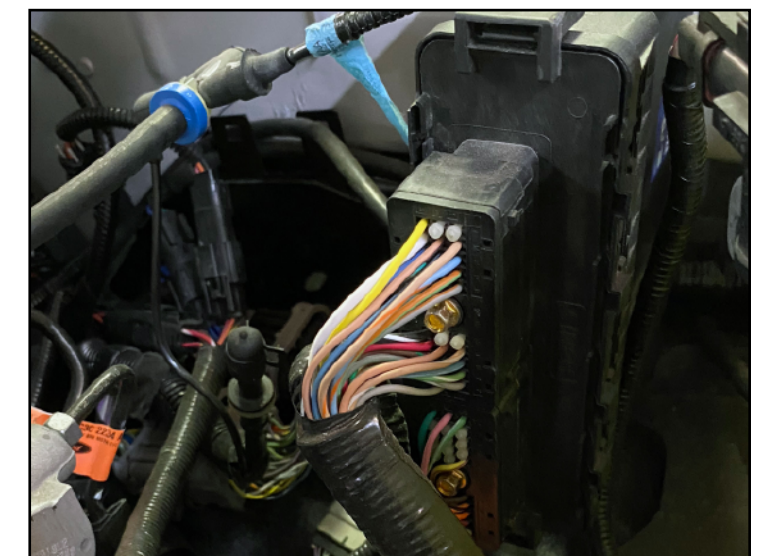
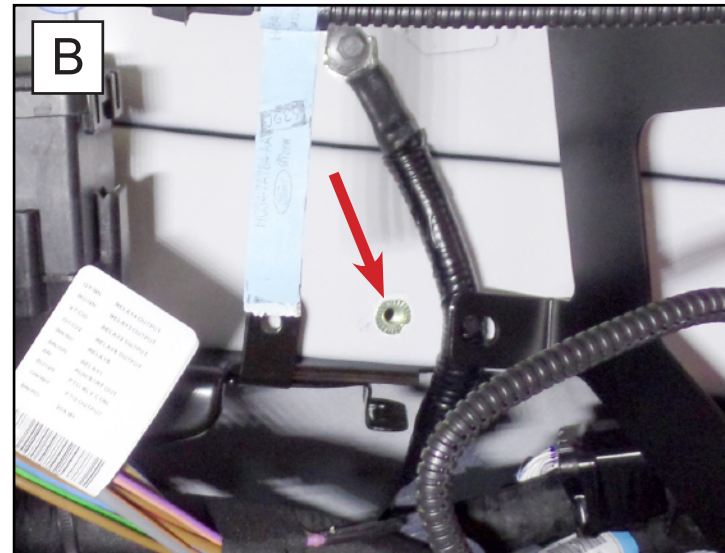
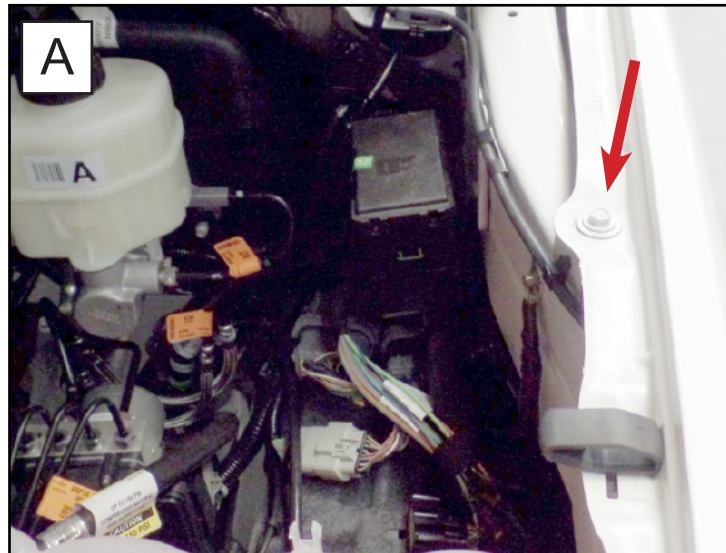

ALTERNATIVE FUEL CONTROL MODULE INSTALLATION (DUAL BATTERY)

Dual Battery AFCM Installation: *Must be ordered as dual battery system, default is single battery option.*

1. Remove OEM nut located on driver side battery holding bracket (pic. A) and save for reuse.
2. Position dual battery AFCM Bracket in place and secure with saved OEM nut.
3. Screw in 16mm bolt to plastic battery bracket already provided by Ford (pic. B).
4. Attach the four provided u-nuts to bracket.
5. Position AFCM on bracket and attach with four provided 1/4" bolts.
6. Connect the main CNG harness to the AFCM.

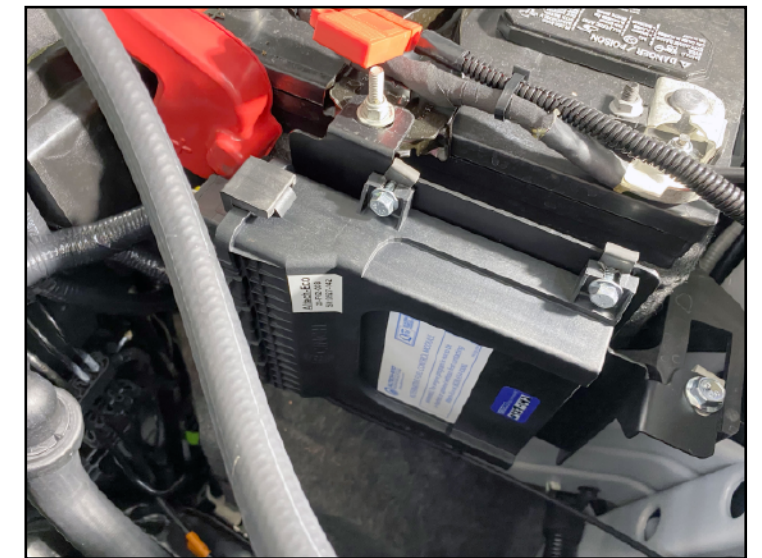
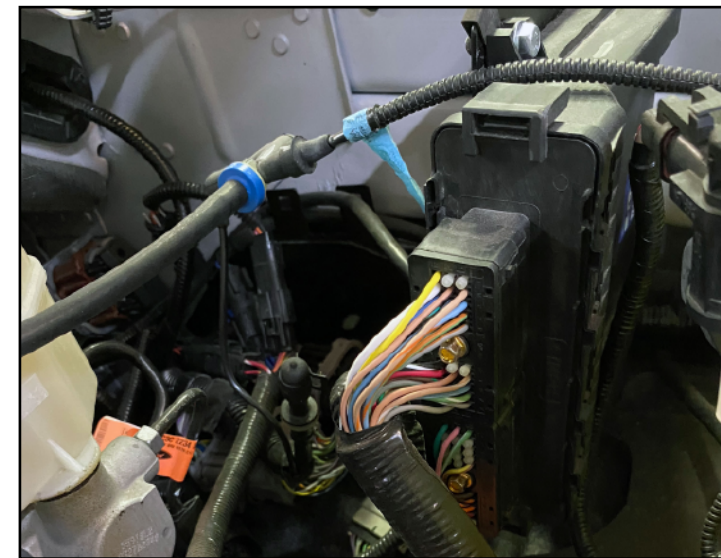
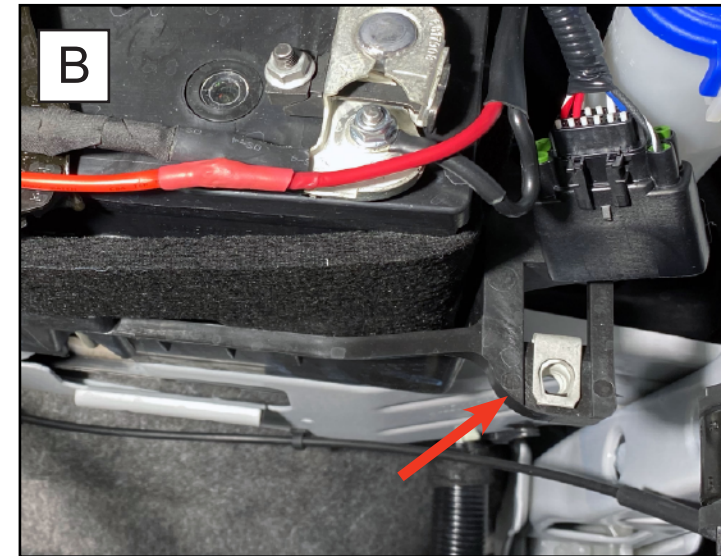
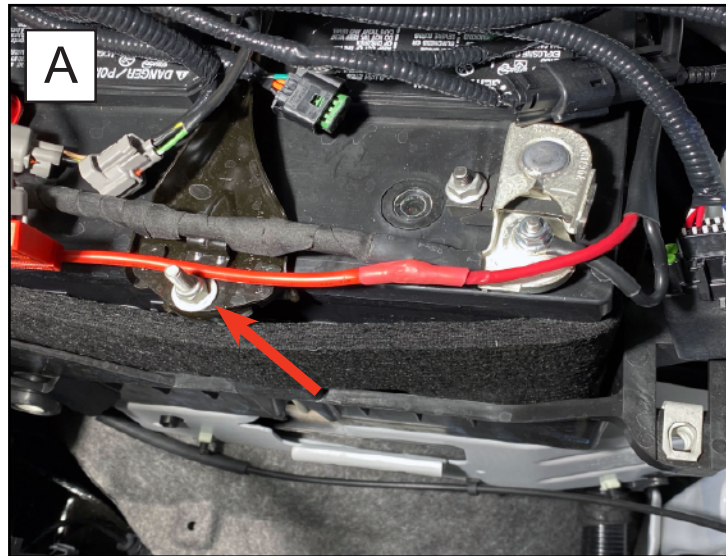

MAIN CNG HARNESS ROUTING

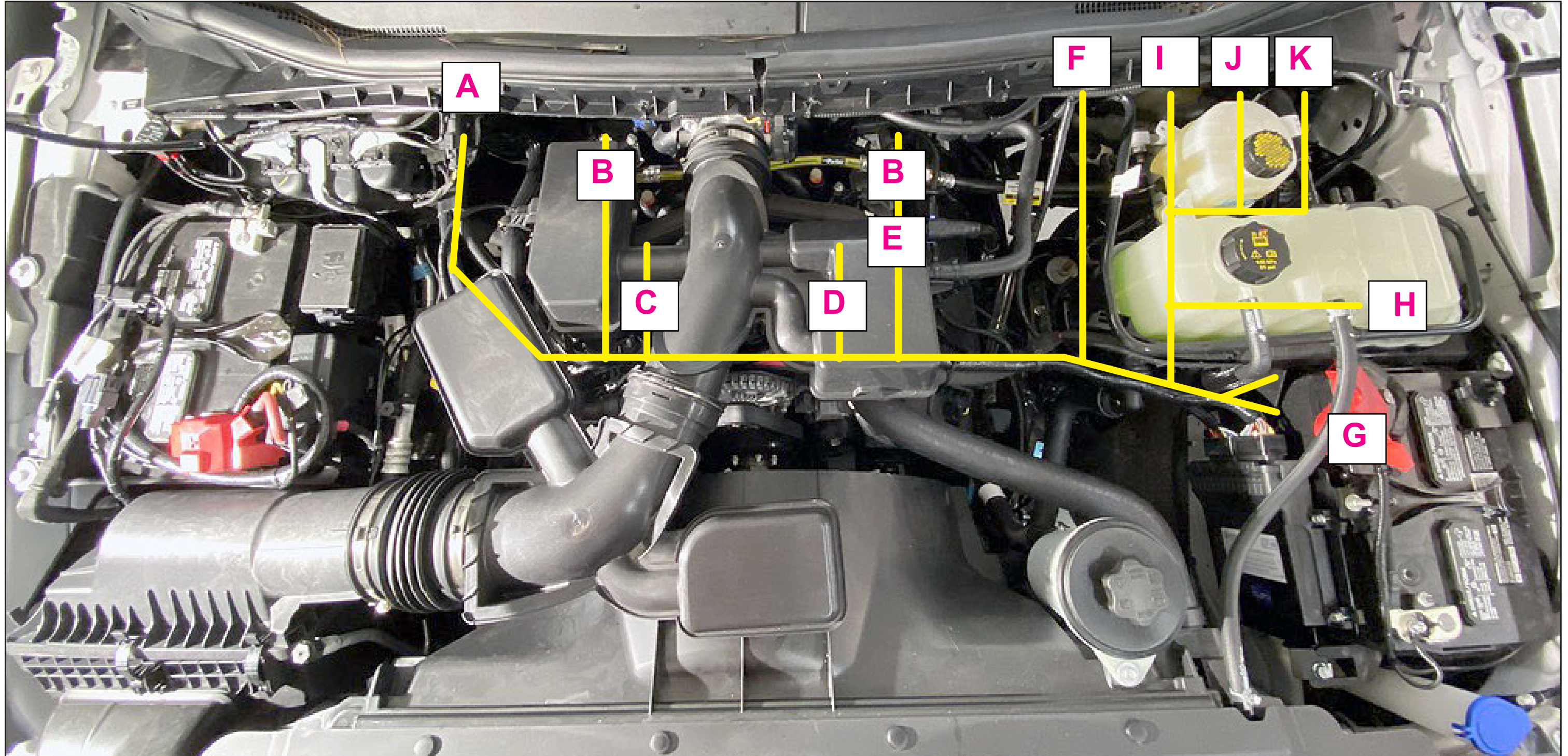

- A. Crank position sensor
- B. CNG injector
- C. Gasoline bank 1 interceptor
- D. Gasoline bank 2 interceptor
- E. CNG fuel rail pressure/temp sensor

- F. MAP sensor
- G. CNG Control Module
- H. CNG Ford prep
- I. Rear harness
- J. Gauge/Switch
- K. Diagnostics

CNG HARNESSSES DIAGRAM

- A. Crank position sensor
- B. CNG injectors
- C. Gasoline bank 1 interceptor
- D. Gasoline bank 2 interceptor
- E. CNG fuel rail pressure/temp sensor
- F. MAP sensor
- G. CNG control module
- H. CNG Ford prep
- I. Rear harness
- J. Fuel gauge/switch
- K. Diagnostics

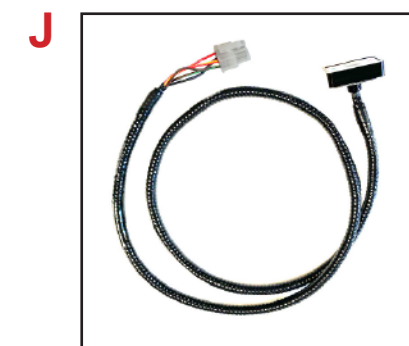
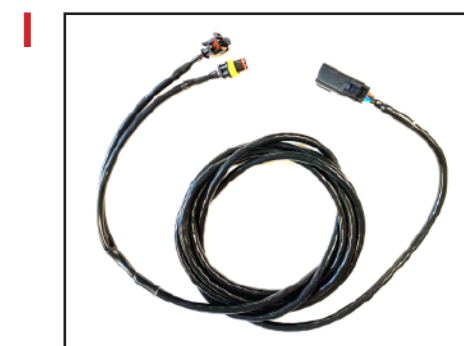
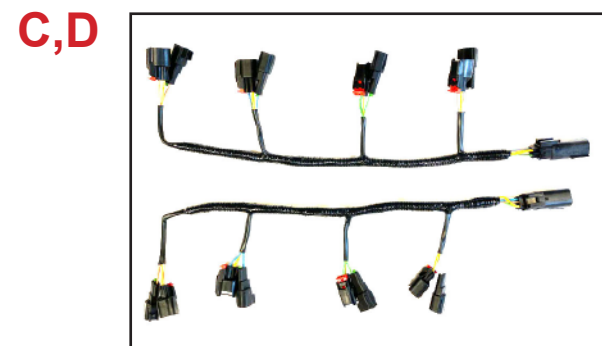
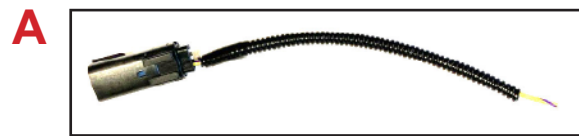
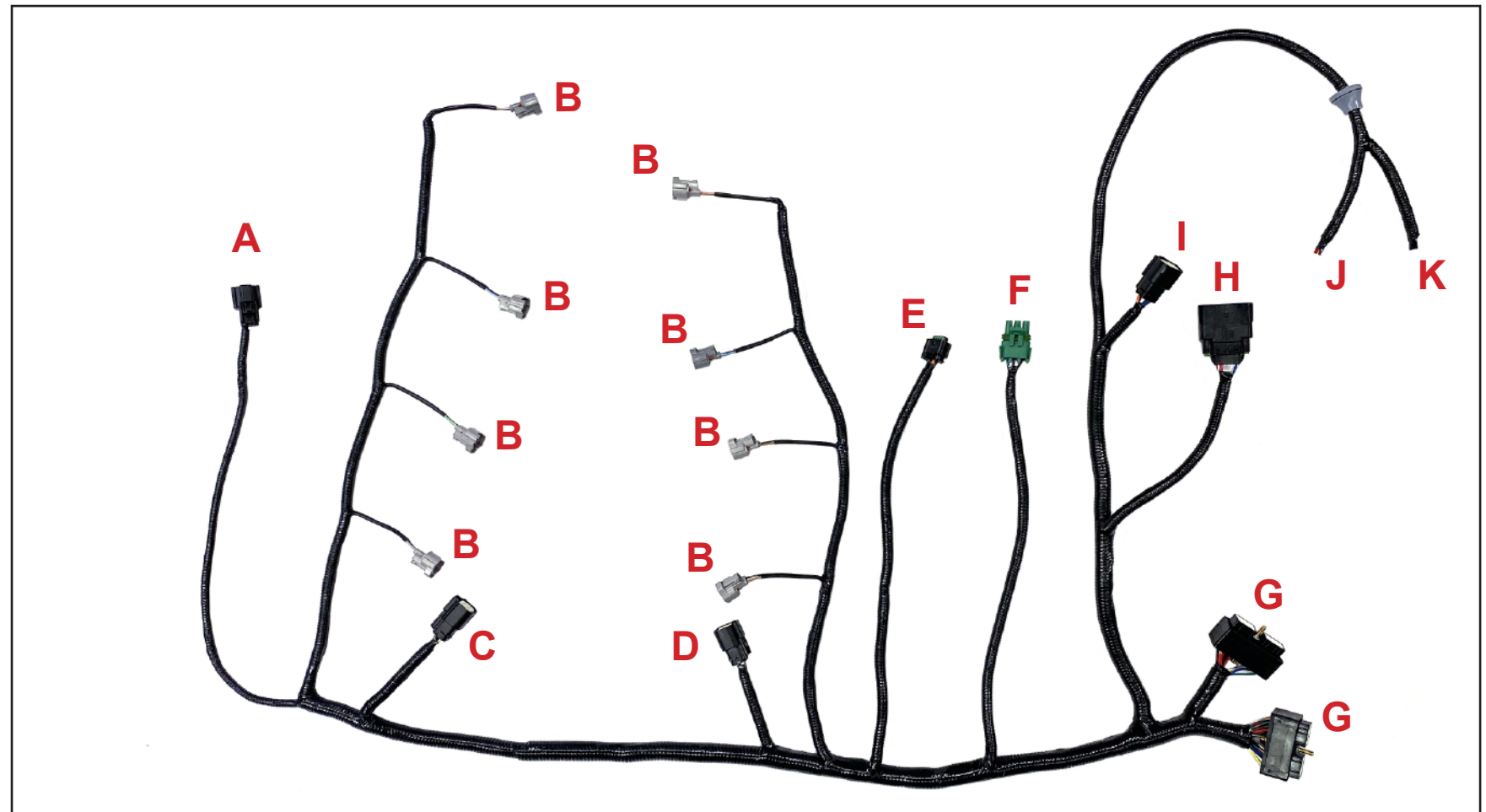

Additional Information:

- Zip tie all wires to original Ford wire harnesses with zip ties where possible. No loose or hanging wires. Wires and hoses are not to be touching any surfaces that may cause cutting, abrasion or deterioration from rubbing or vibrations. Over time vibration and engine movement can cause damage and abrasion to wiring.
- Cut off remaining zip tie ends for a clean installation.

CRANK POSITION SENSOR WIRE INSTALLATION

1. Remove middle plug cover located at Ford PCM. Remove grey locking cap inside plug cover.
2. Remove tape from wiring approximately 12" down from connector. Save tape to be reused. Remove black wire plug cover to expose wires.
3. Use pin-out, locate pin 99, wire (yellow/violet stripe) and remove the terminal and wire from connector. Tip: Use a silver colored metallic marker to mark pin hole for easy reference later.
4. Approximately 2-1/2" down from terminal, splice the wire. Twist together the Crank position wire to the spliced wire.
5. Slide shrink tube on wire and solder together. Heat shrink tube to attach.
6. Re-attach black wire plug cover and tape. Re-attach grey locking cap inside plug cover.
7. Re-connect the middle plug cover located at Ford PCM.
8. Connect plug crank position sensor connector to the main CNG harness.
9. Zip tie any loose wires.

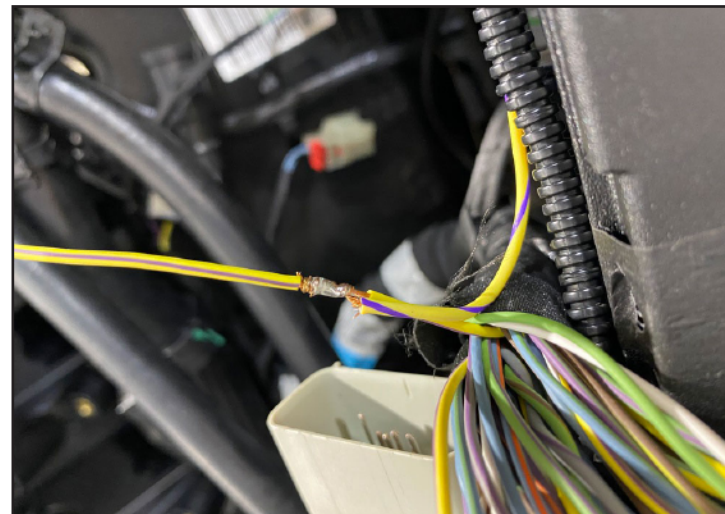
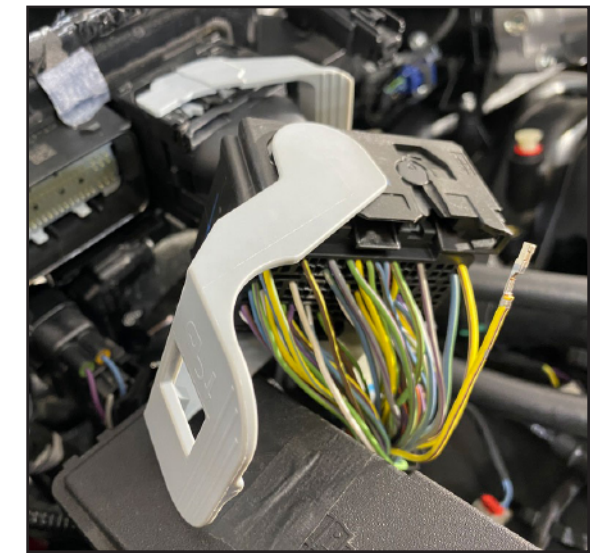
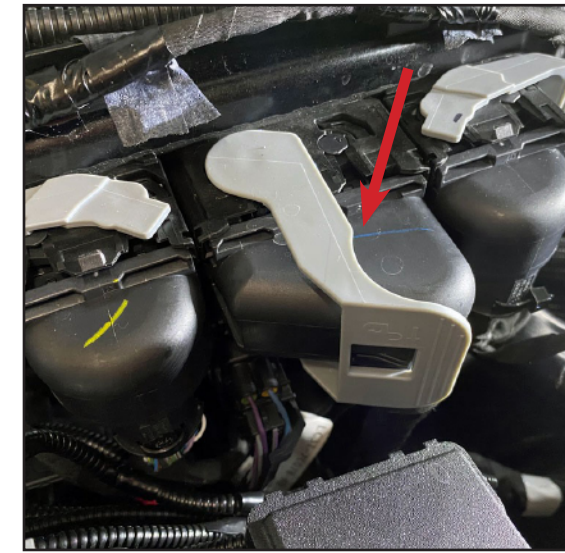
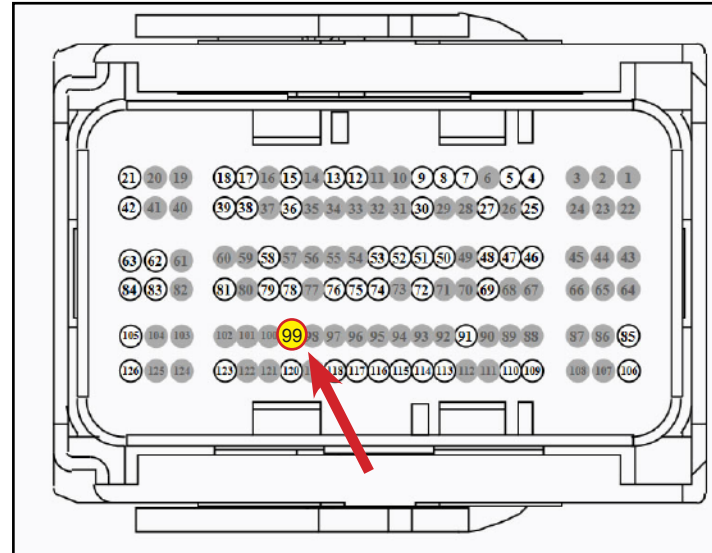

CNG INJECTOR CONNECTORS

1. After CNG injectors and fuel delivery assembly has been installed.
2. Connect main CNG harness to CNG injectors.
3. All wiring is to be zip tied to original Ford harnesses when possible.

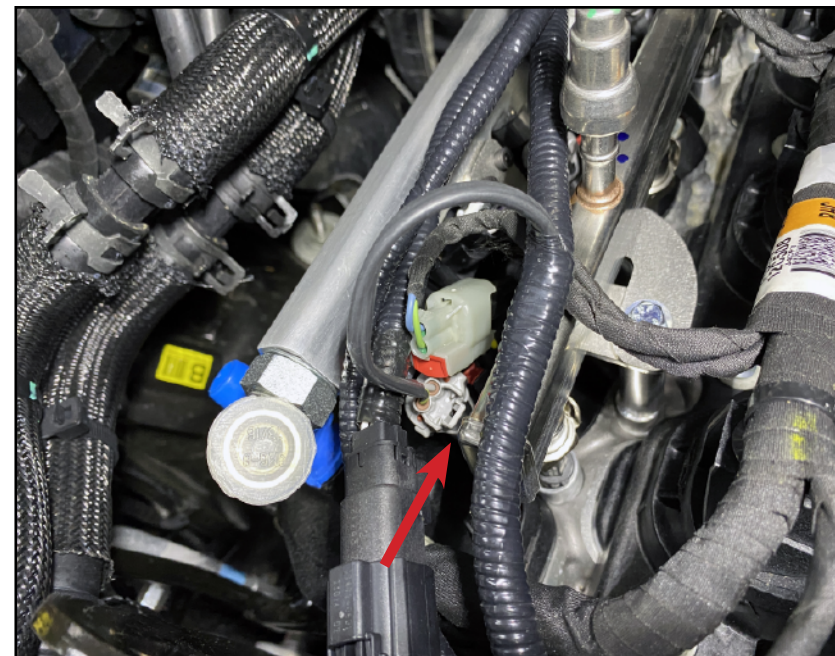
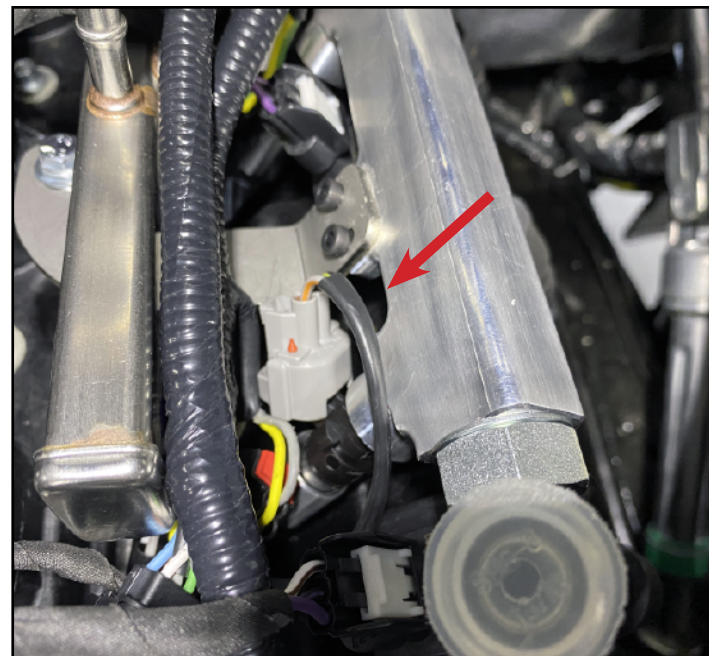

GASOLINE BANK 1 & 2 INTERCEPTOR WIRING

1. Install before CNG fuel rail assemblies installation.
2. One per side of engine.
3. Disconnect Ford gasoline injector harness. Connect Interceptor to gasoline harness and the gasoline injector.
4. Single connector attaches to CNG main harness.
5. Route and zip tie to original Ford harnesses.

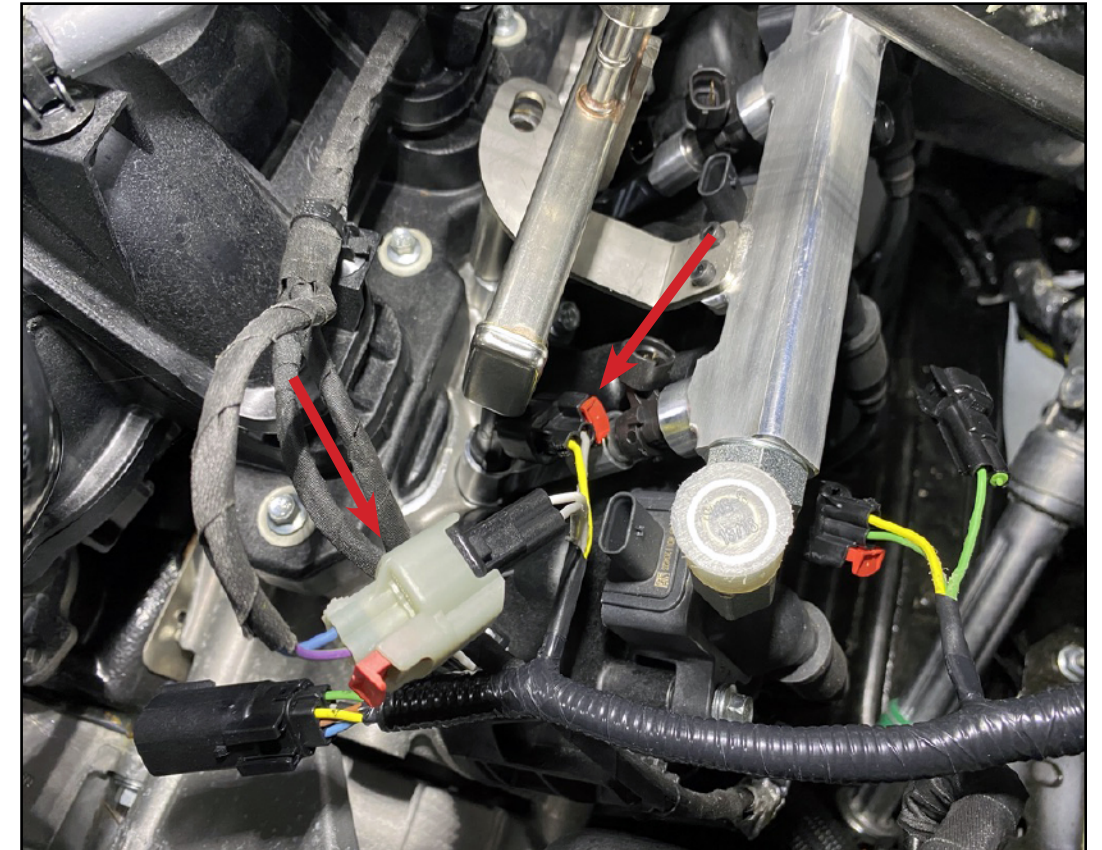
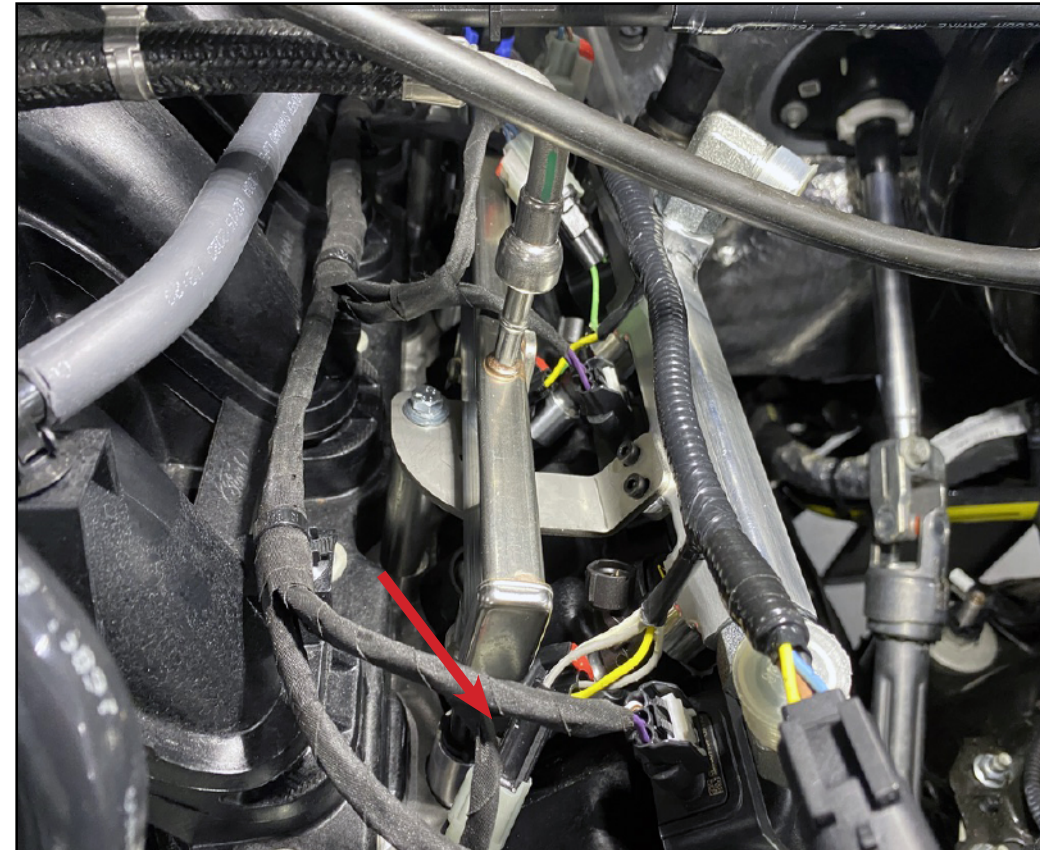
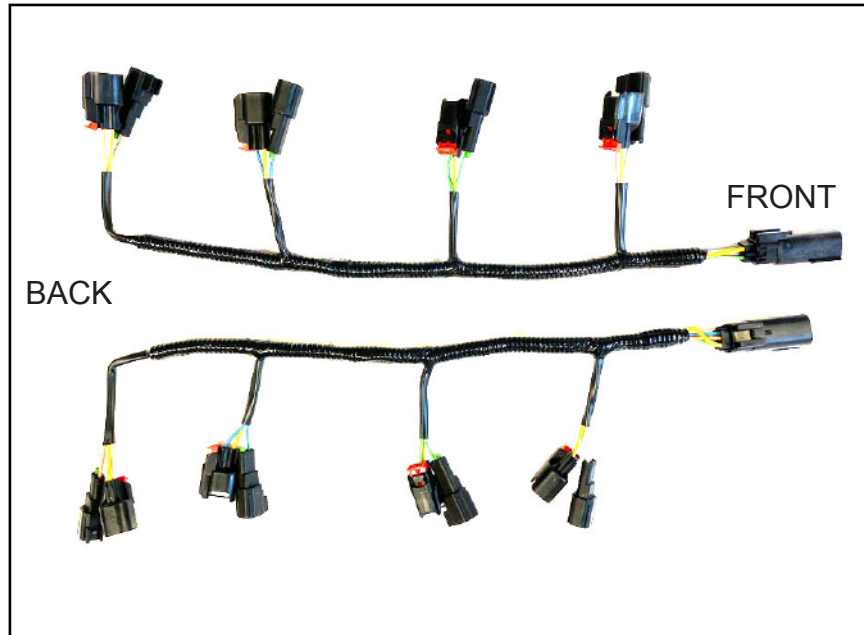

CNG FUEL RAIL PRESSURE AND TEMPERATURE SENSOR WIRING

1. See Low Pressure Installation Instructions section for details.
2. The CNG fuel rail pressure and temperature sensor connector is included on CNG main harness. This connection is to be made while installing the CNG low pressure fuel rails, etc...
3. The sensor is located on CNG fuel rail (driver side). Sensor is pre-installed on fuel rail with system.
4. All wiring is to be zip tied to original Ford harnesses when possible.

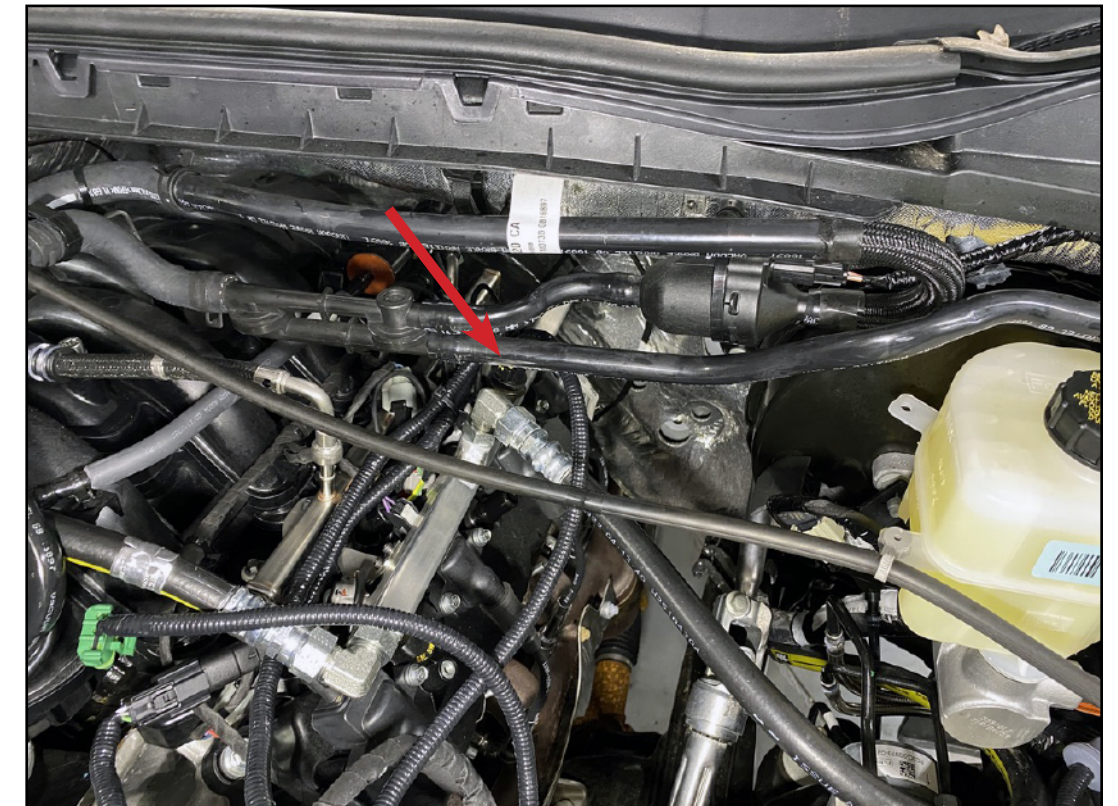
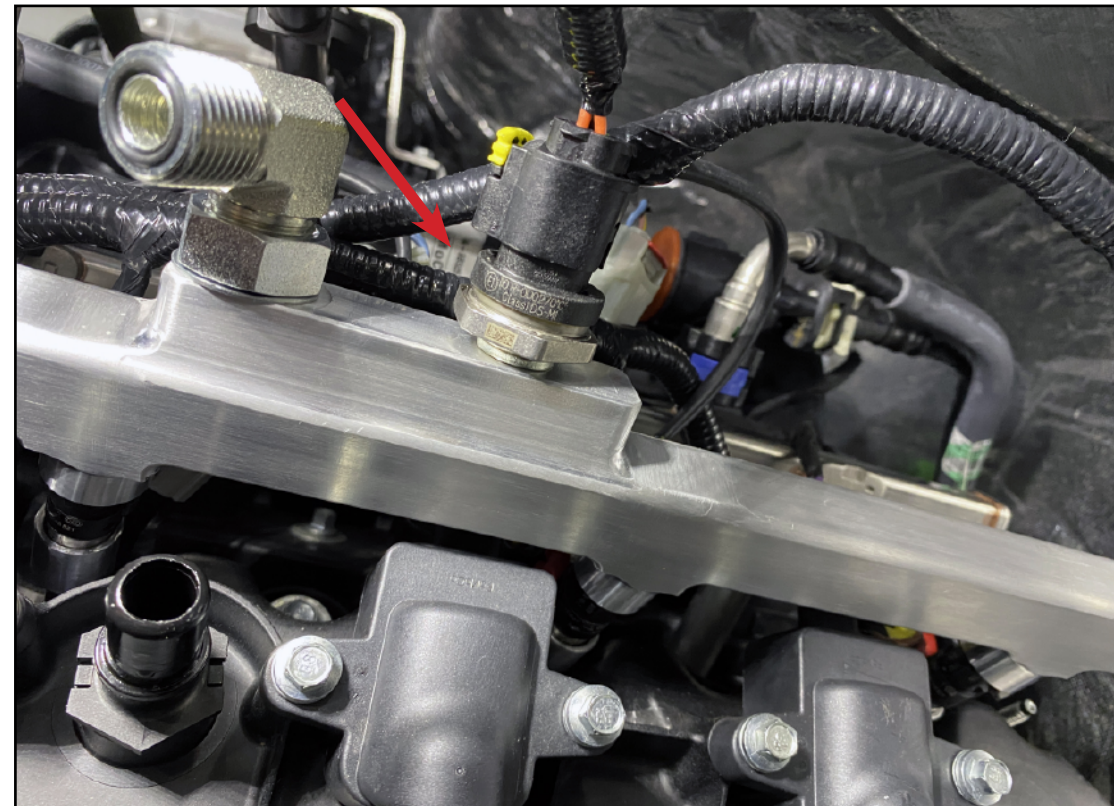

MAP SENSOR INSTALLATION

1. Locate top of engine fire wall on driver side. Place MAP sensor in location shown in picture with connector facing down and drill in two self tapping 3/8" screws.
2. Connect CNG main harness to Sensor.
3. Locate vacuum hose and cut to line up with sensor. See picture.
4. Apply silicon to T fitting and insert into vacuum hose facing towards MAP sensor.
5. Apply silicon to each end of supplied hose and attach to MAP sensor and T fitting.
6. All wiring is to be zip tied to original Ford harnesses when possible.

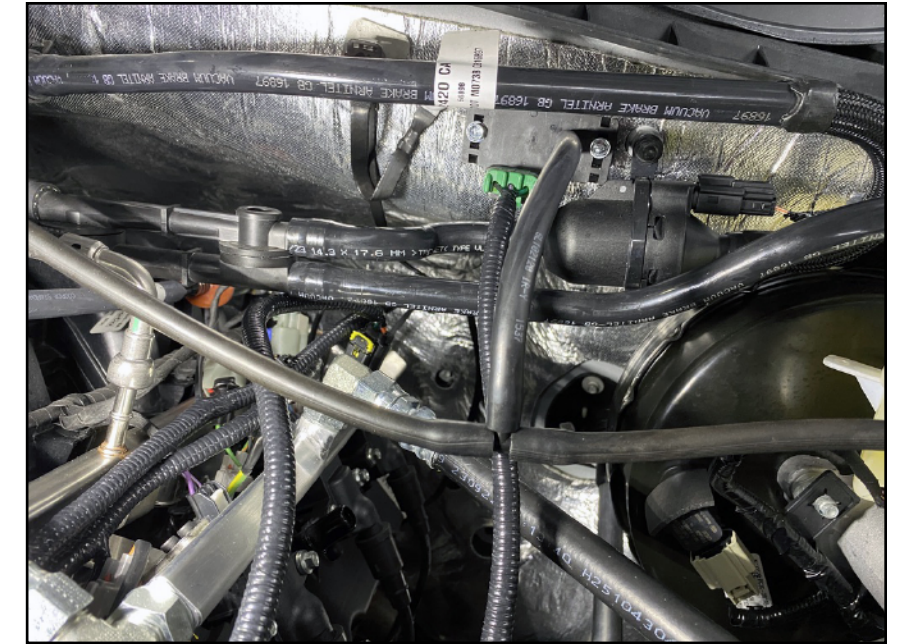
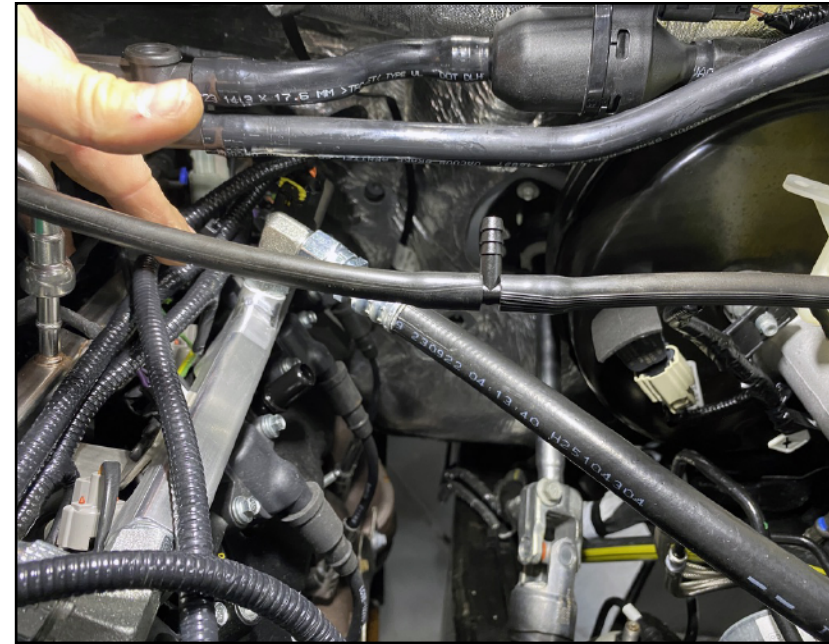

CNG CONTROL MODULE WIRING

1. Plug CNG main harness into CNG control module. Two connectors.
2. All wiring is to be zip tied to original Ford harnesses when possible.



FORD PREP WIRING

1. Locate the Ford provided CNG prep connector. It is located on driver side near fire wall and front wheel well cover.
2. The Ford provided CNG prep connector is to be disconnected and returned to Altech-Eco. We have supplied a new connector on CNG main harness.
3. Connect the CNG main harness to the CNG prep connection.
4. All wiring is to be zip tied to original Ford harnesses when possible.



Send to Altech-Eco after removed.

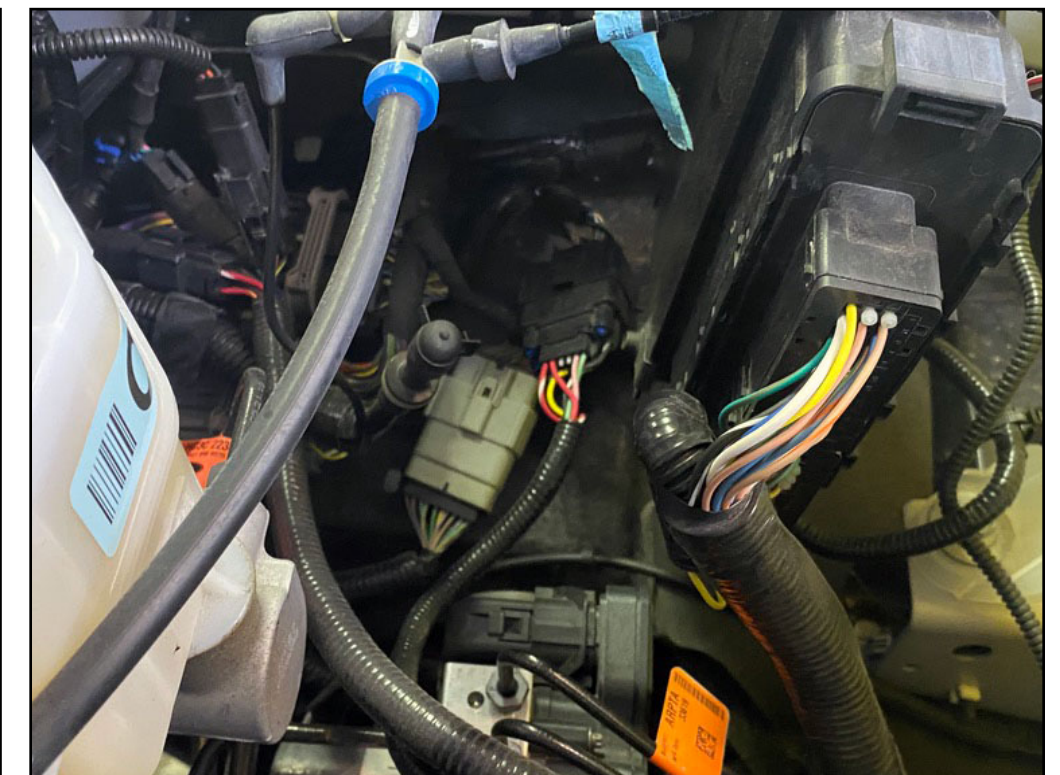
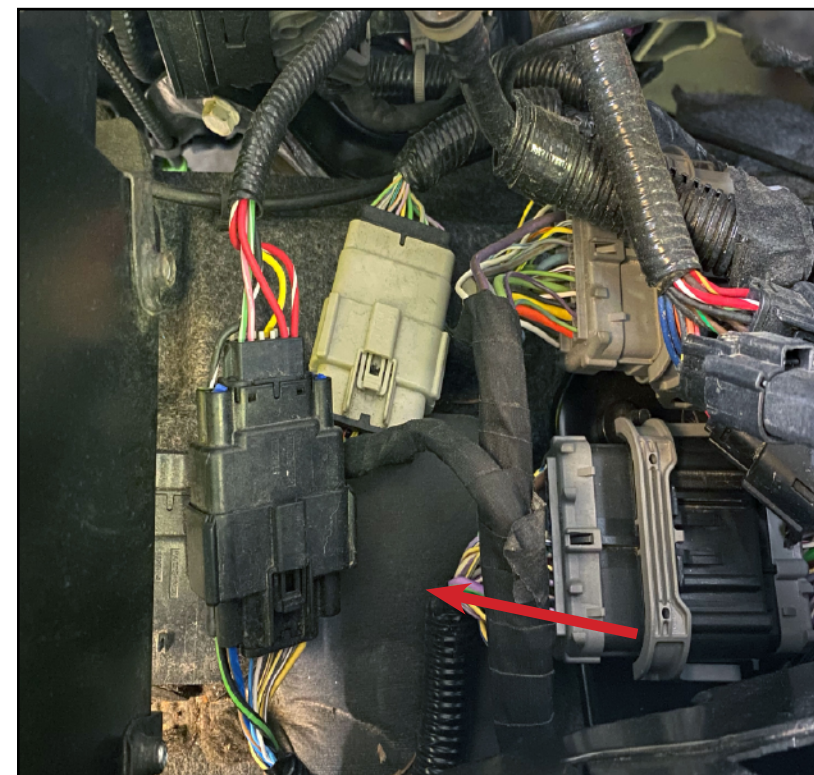

SWITCH / GAUGE & DIAGNOSTICS WIRING INSTALLATION

1. Below the steering column in the location shown, drill a 7/8" hole. Deburr and rust proof. This hole will be used for the switch gauge harness leading into the engine compartment.
2. Feed the switch/gauge harness through the hole and into the engine compartment. Secure the harness grommet.
3. Attach to the main CNG harness (see Main CNG Harness wiring section).
4. Zip tie the diagnostic cable and switch gauge wires as shown.
5. Make sure there are no loose wires hanging down. All wires must be secured and out of the way for driver operation and safety.

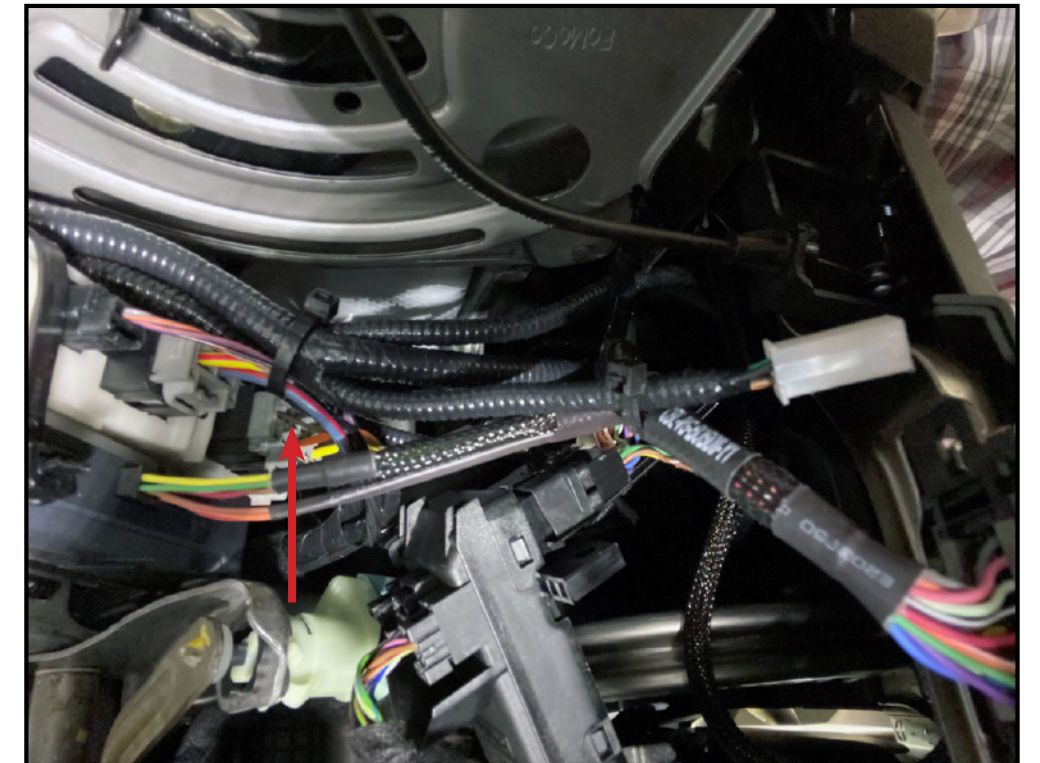
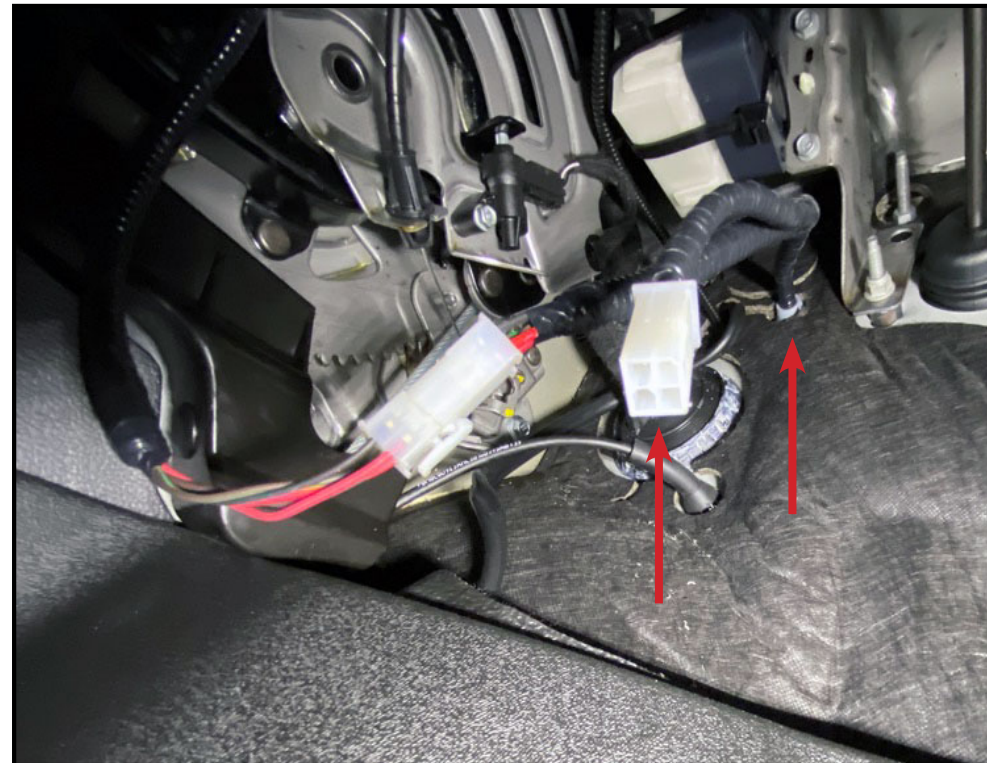
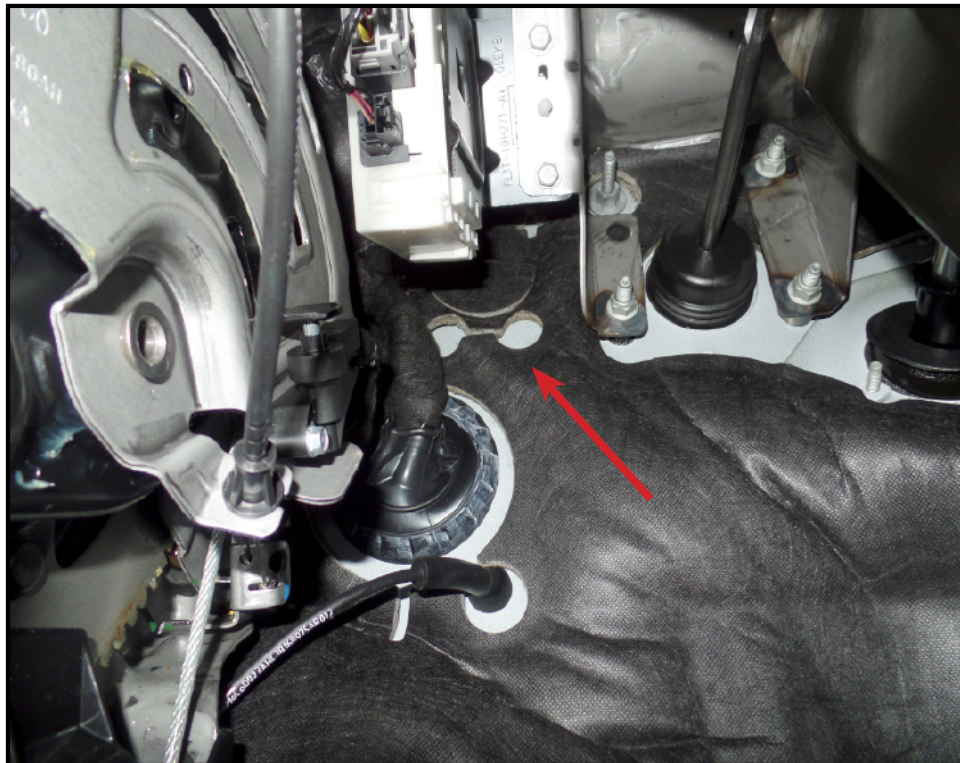

SWITCH / GAUGE INSTALLATION

1. Remove plastic panel carefully.
2. Cut the square section on dashboard that has the white push clip.
3. See drill measurements and cut/drill out opening for the switch on plastic panel removed.
4. Clean surface around hole with alcohol, remove sticker adhesive backing on switch and screw the switch into correct position for viewing by driver.
5. Feed wiring down through square opening in dashboard and attach to connector from engine compartment.
6. Make sure all wires are zip tied out of the way and there are no loose hanging wires. Be sure to leave the diagnostic connector accessible.
7. Reattach plastic panel to its original position. Be sure not to pinch any wires.

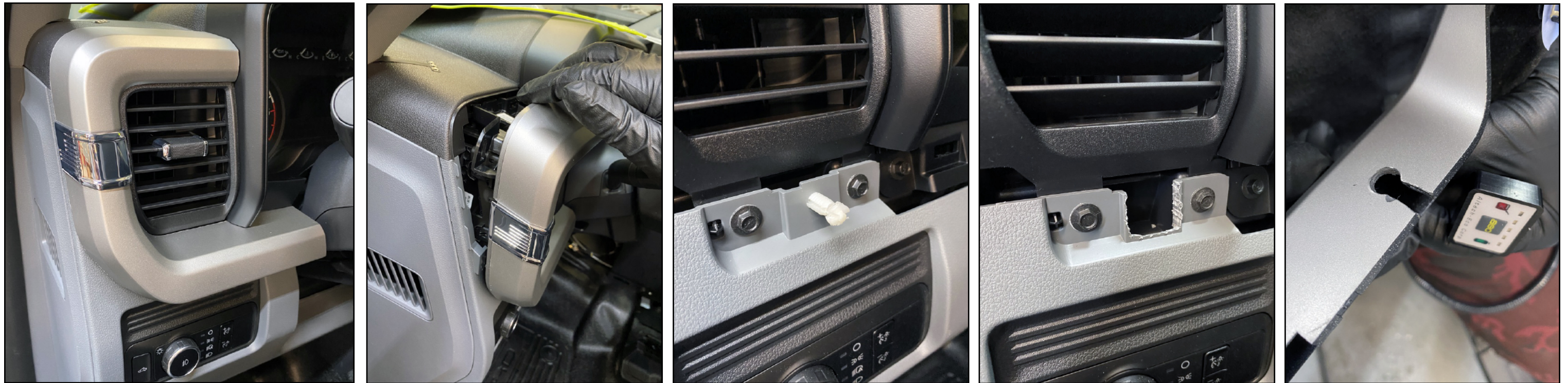
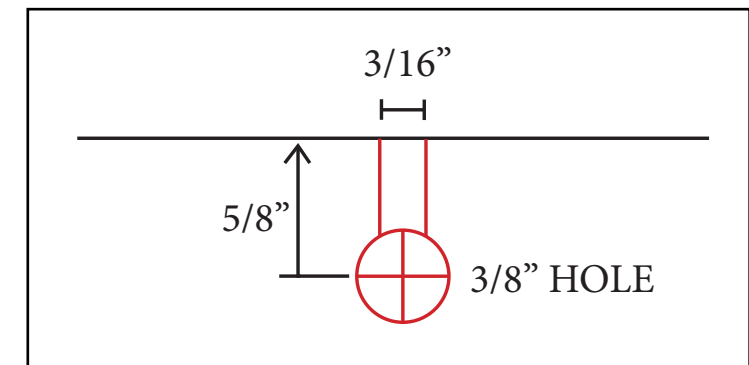

LOW PRESSURE FUEL HOSE ROUTING & INSTALLATION

1. Begin by connecting the first of two low pressure fuel hoses to the CNG fuel rail. Torque hose connection to 30-35 ft-lbs. Attach a low pressure sticker on LP hose near fuel rail.
2. Run the LP hose down through engine compartment (driver side) and under vehicle along the path as shown in pictures and connect LP hose to the quarter turn valve (see quarter valve installation section). Torque hose connection to 30-35 ft-lbs. Secure LP hose with a P-clamps.
3. Connect the second LP hose to the quarter turn valve and run the LP hose along the path as shown in pictures, up through grommet in bed and connect the LP hose to the regulator located at the cylinder package. Torque hose connection to 30-35 ft-lbs. Secure LP hose with a P-clamps.

- No loose hanging wires or hoses. Wires and hoses are not to be touching any surfaces that may cause cutting, abrasion or deterioration from rubbing or vibrations. Over time vibration and engine movement can cause damage and abrasion to wiring. Cut off remaining zip tie ends for a clean installation.

P-clamp securing locations will vary depending on cab size / bed size. Photos below from Crew Cab / 8ft Bed.

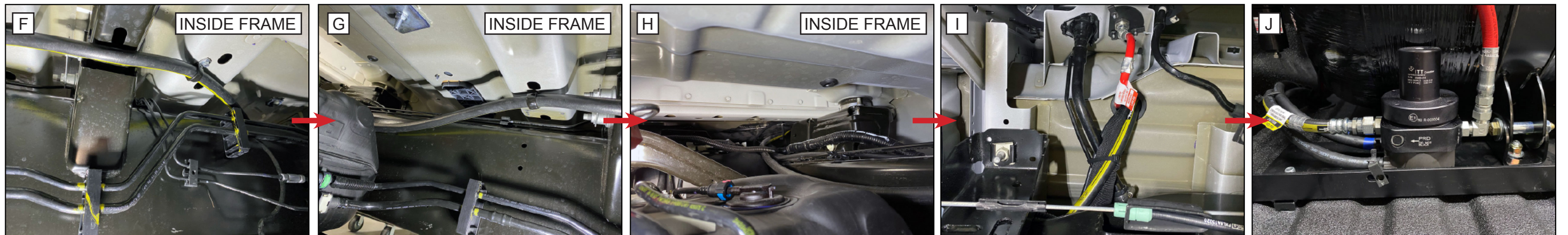
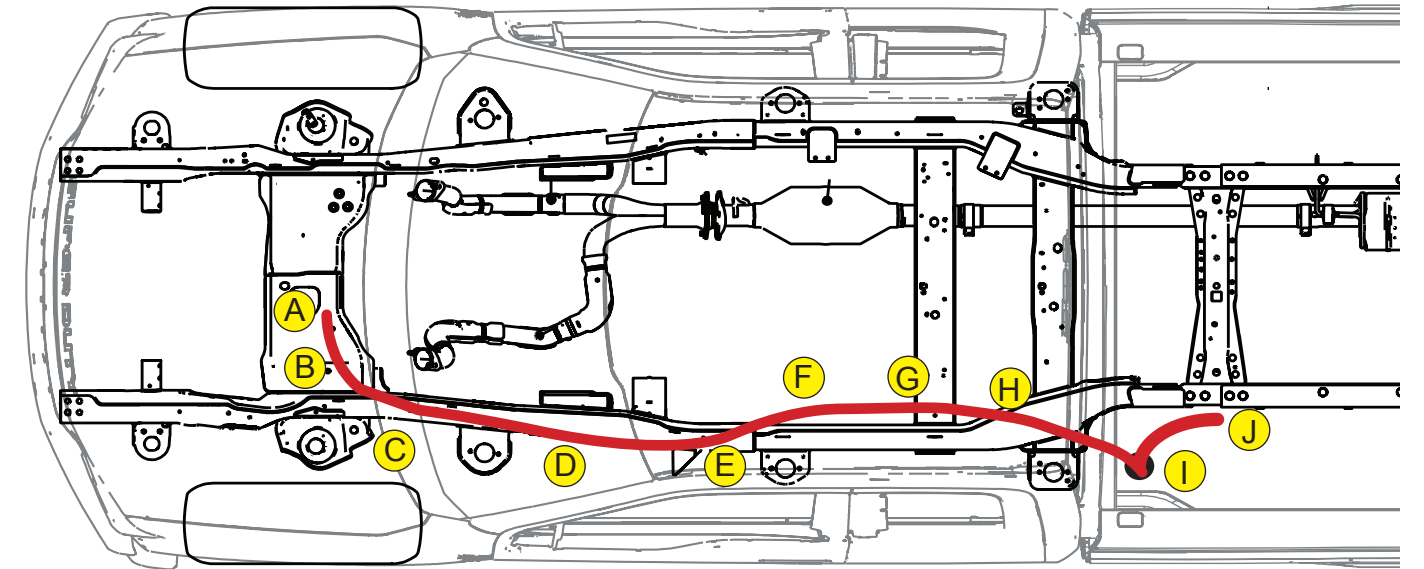

REAR WIRE HARNESS ROUTING & INSTALLATION

1. Begin by connecting the rear harness to the CNG main harness in engine compartment.
2. Run the rear harness down through engine compartment (driver side) and under vehicle along the path as shown in pictures. Secure the rear harness with zip ties to original Ford wire harness along frame.
3. Continue the rear harness up through grommet in bed and connect to solenoid valve and pressure sensor located at the cylinder package. Secure the rear harness with zip ties.

- No loose hanging wires or hoses. Wires and hoses are not to be touching any surfaces that may cause cutting, abrasion or deterioration from rubbing or vibrations. Over time vibration and engine movement can cause damage and abrasion to wiring. Cut off remaining zip tie ends for a clean installation.

Zip tie locations will vary depending on cab size / bed size. Photos below from Crew Cab / 8ft Bed.

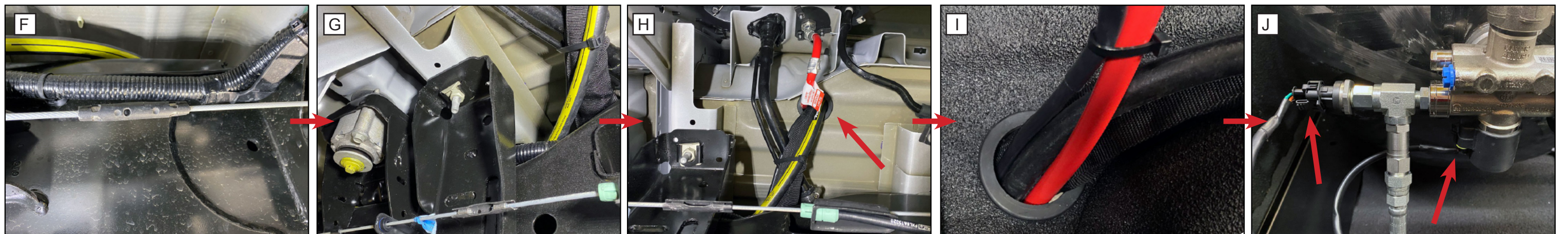
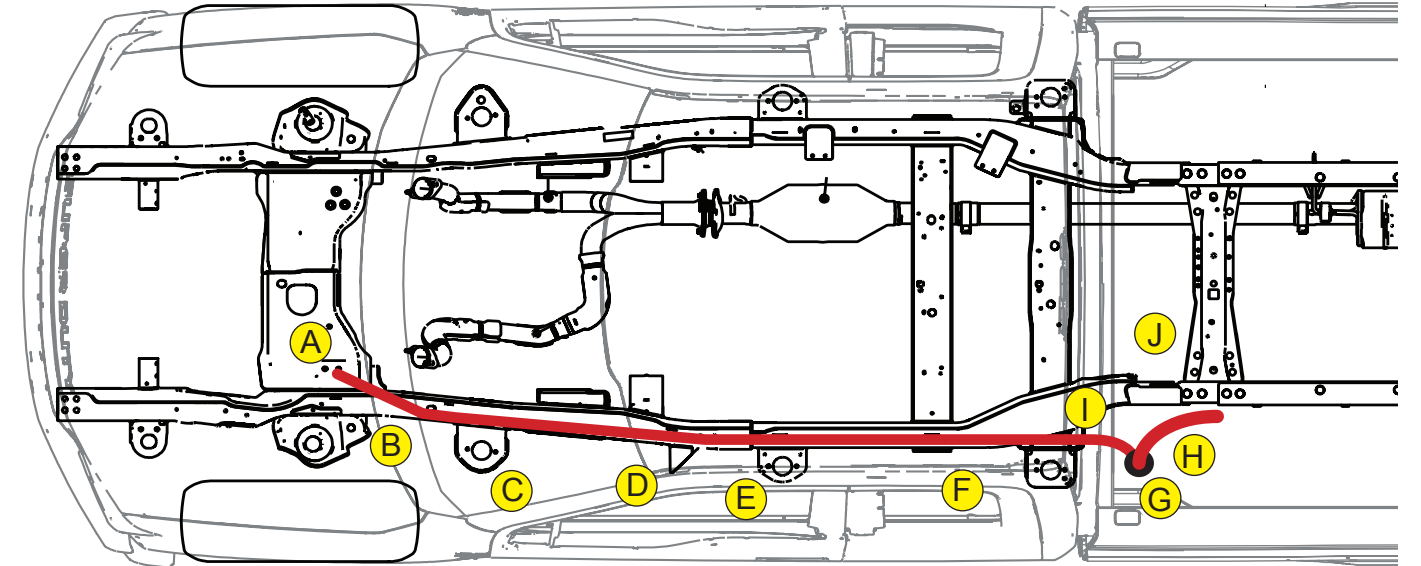

COOLANT HOSES ROUTING & INSTALLATION

- Two coolant hoses are to be routed from regulator on tank package, through bed grommet, inside the frame under body, and through the wheel well into the engine compartment. See diagram for routing. Secure hoses with 1-1/8" p-clamps. No loose or hanging hoses.
- Connect hoses to the regulator with hose clamps.
- Tap into the Ford coolant lines in engine compartment. Coolant splitter "Y" facing towards engine fire wall. Secure with hose clamps. **(Some coolant fluid will escape. Top off the coolant after installation).**

- Hoses are to be clear of exhaust or suspension parts that may damage hoses.
- No loose hanging wires or hoses. Wires and hoses are not to be touching any surfaces that may cause cutting, abrasion or deterioration from rubbing or vibrations. Over time vibration and engine movement can cause damage and abrasion to wiring. Cut off remaining zip tie ends for a clean installation.

P-clamp securing locations will vary depending on cab size / bed size.

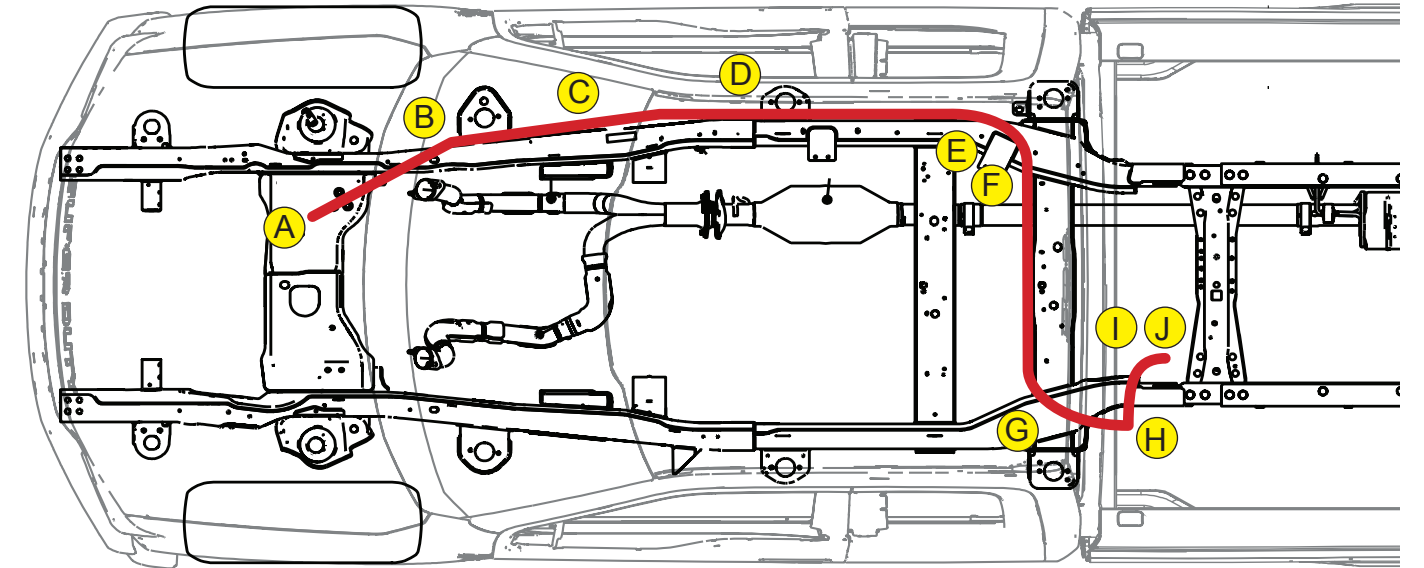

Wheel cover pulled back to see hoses.



CYLINDER COVER - STANDARD DIAMOND PLATE

1. Place sticker on the inside of the cylinder cover and on the cylinder bracket closest to the valve. This sticker must be clearly visible for safety reasons. Cover must be installed for normal operation.
2. Place eight u-nuts (333) on front and back cylinder plates.
3. Place cover over cylinder and secure with eight 1/4-20 x 1" bolts (334).

Perform a leak test before placing cover!

WARNING
CNG CYLINDER COVER MUST BE IN
PLACE FOR NORMAL OPERATION.
G-D0609

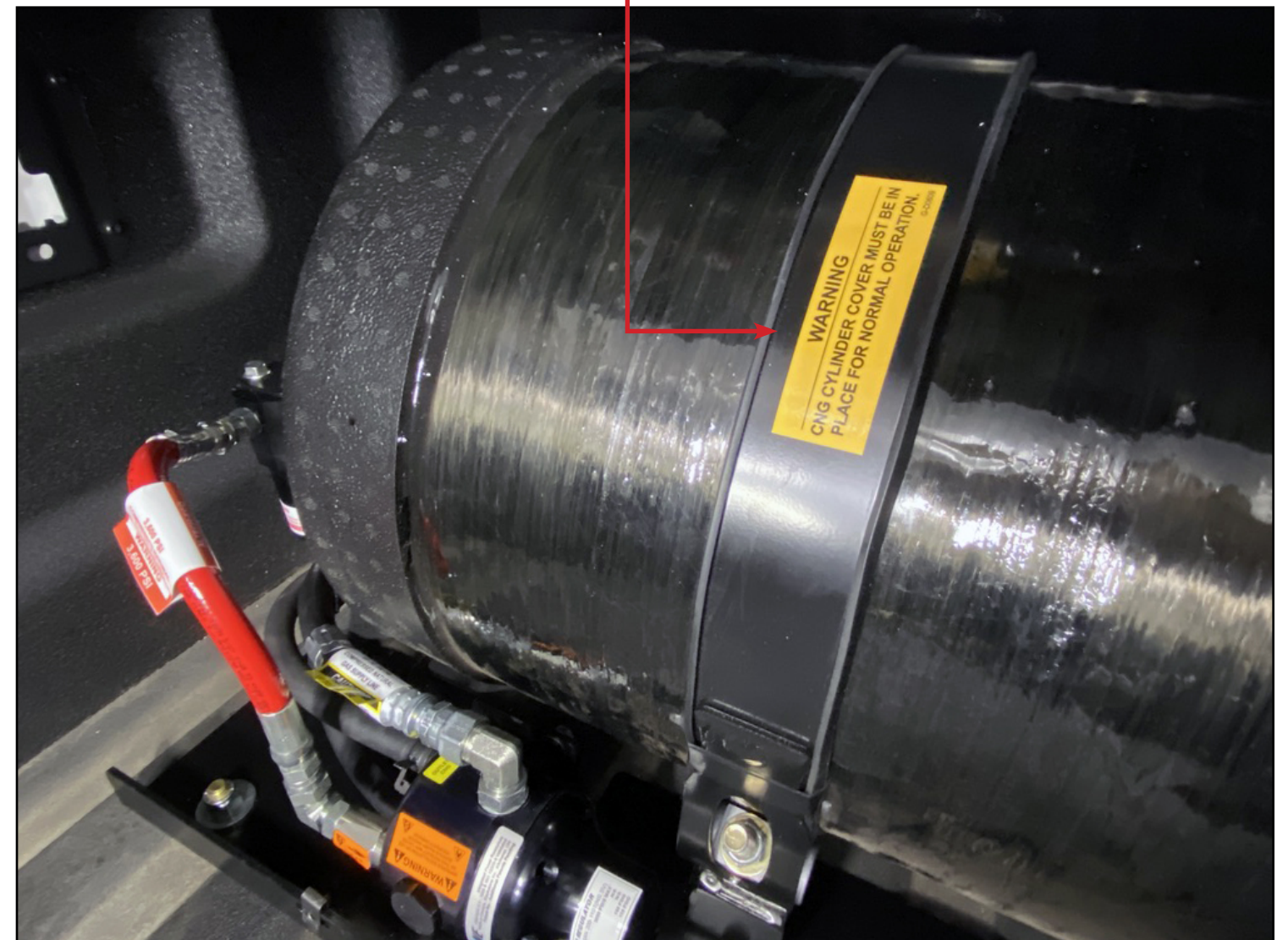

CYLINDER COVER - TOOL BOX OPTION

1. Place the toolbox over the cylinder.
Secure toolbox to the truck bed with four hooks (two on each side) and bolts supplied with kit.
2. Place four u-nuts (333) onto rear cylinder base plate.
Drill four holes on toolbox lip and place four u-nuts (333).
3. Place sticker on the inside of the skirt. Sticker must be clearly visible for safety reasons. Cover must be installed for normal operation.
Place sticker inside the cylinder cover and one on cylinder strap closest to the valve.
4. Place skirt into place and secure with eight 1/4-20 x 1" bolts (334).

Perform a leak test before placing cover!

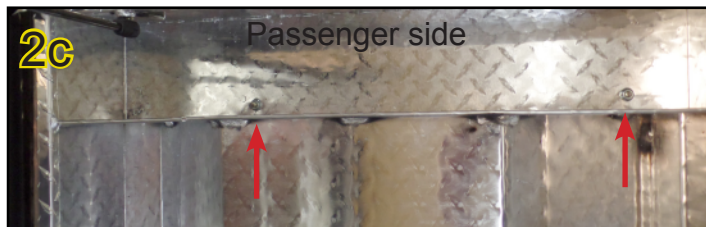

WARNING
CNG CYLINDER COVER MUST BE IN PLACE FOR NORMAL OPERATION.
G-D0609

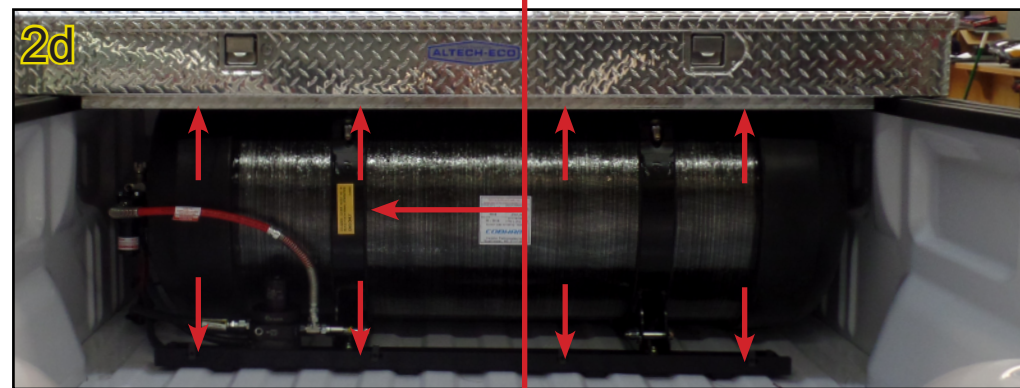

STICKER PLACEMENTS



Placed on driver and passenger door.



Placed by quarter turn shut-off valve.



All high pressure hoses must be labeled with a high pressure sticker.



Placed on inside of hood.

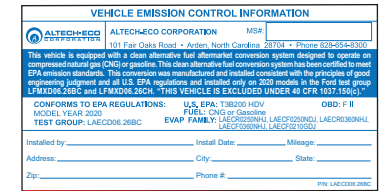

Placed on inside of hood.

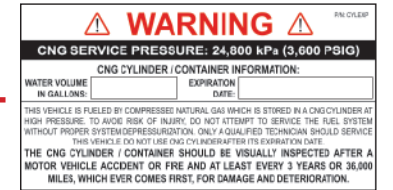

WARNING: The engine program is not to be re-flashed or updated without first contacting the engine gaseous modifier.
 Program Questions Call: 828-654-8300 

Placed on Ford ECU.



Placed on plastic cover in front.

STICKER PLACEMENTS

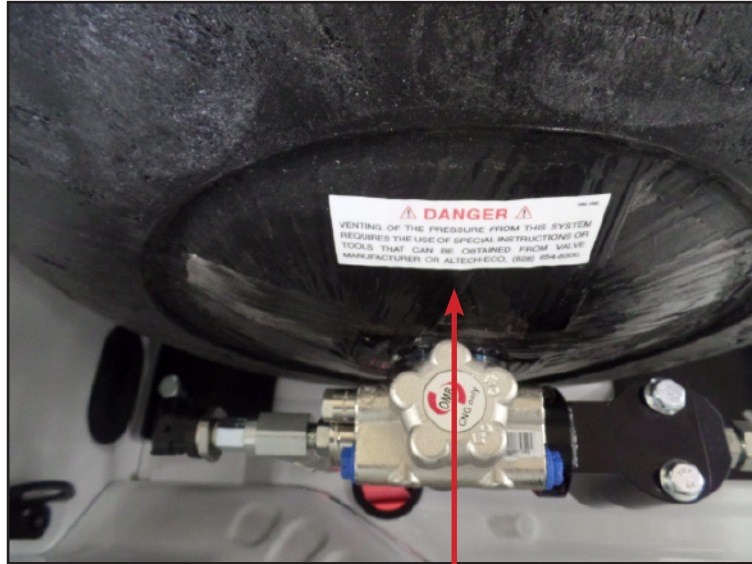

⚠ DANGER ⚠ PIN: VWL
 VENTING HIGH PRESSURE FROM THIS NATURAL GAS SYSTEM MUST BE DONE BY TRAINED PERSONNEL ONLY AND REQUIRES SPECIAL TOOLS AND INSTRUCTIONS THAT CAN BE OBTAINED FROM THE FUEL CYLINDER VALVE MANUFACTURER.

Place near tank valve



WARNING: The engine program is not to be re-flashed or updated without first contacting the engine gaseous modifier.
 G-E0804-1 Program Questions Call: 828-654-8300 **ALTECH-ECO CORPORATION**

Place near OBD connection

Remove E85 text from gasoline cap. This vehicle can no longer use E85.



CNG ONLY 3,600 PSI PIN: CNG0NL1-1
 THE CNG CYLINDER SHOULD BE INSPECTED EVERY 3 YEARS OR 36,000 MILES.

Place near CNG fuel receptacle

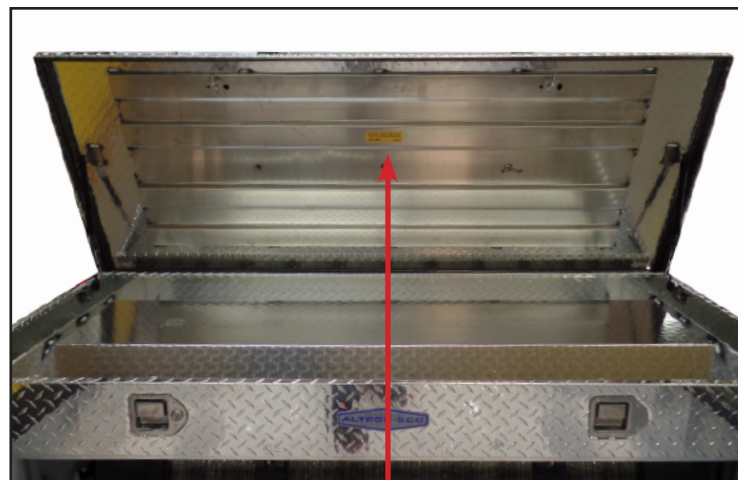

Place under lid.



WARNING
 CNG CYLINDER COVER MUST BE IN PLACE FOR NORMAL OPERATION.
 G-00605

Locations vary with different covers.

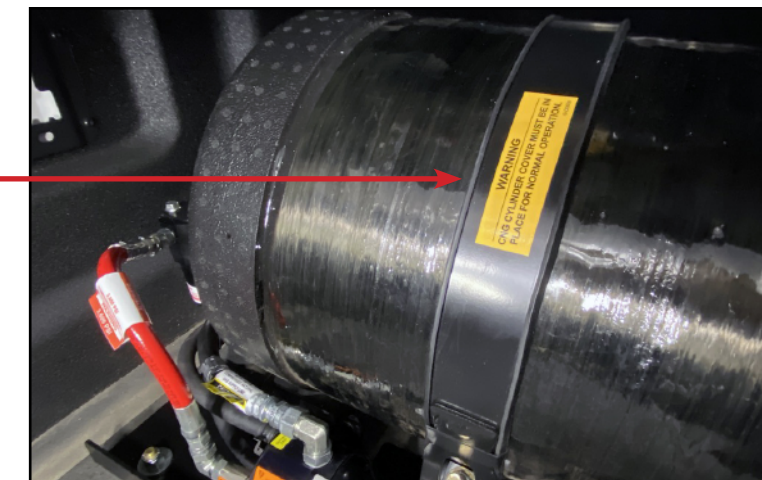

Place on tank strap bracket under lid.

QUALITY CONTROL, FINAL INSPECTION AND LEAK CHECKING THE SYSTEM

A final inspection checklist must be completed after the CNG system has been installed on the vehicle. This can be found on installer portal page on Altech-Eco website. After completing the final checklist, it is required that an original or a copy of the entire completed checklist be sent to Altech-Eco and original kept at installer location.

Leak Test: All fuel connections, hoses, fittings, valves, end plugs, fuel rails, injectors, etc... A leak test must be performed by a qualified technician prior to releasing the vehicle to an end user or customer.

Tools:

- Combustible Gas Leak Detector TPI 721 (Davis Instruments)
 - Soapy Water Solution or Liquid Leak Check Solution
1. Double check and verify wiring is correct and secure with nothing hanging loose. Check that zip ties are snipped properly to avoid potential injury.
 2. Check and verify that all installed hoses and fittings are not loose and are secure per torque specifications.
 3. Close the valve by turning clockwise and pressurize the system to 3600 psi.
 4. Leak test using a methane detector or bubble soap.
 - a. **PASS:** Continue to step 5.
 - b. **FAIL:** Depressurize the system and correct the issue before continuing.
 5. Open the manual valve on the fuel tank. Using your hand, rotate the manual valve counter clockwise until fully open. Then close the valve back 1/4 turn (this will help avoid the valve from sticking in the future).
 6. Fill the tank with CNG.
 7. Pressurize the system by turning the ignition on but do not start the vehicle (3 key cycles). This opens the solenoid and fills the lines.
 8. Turn the ignition off, then turn ignition back on and start the engine. This is to pressurize the lines again. While the engine is running, perform a leak test by using a methane detector or bubble soap.
 - a. **PASS:** Complete required paper work and notify your supervisor.
 - b. **FAIL:** Turn off the ignition and manually shut-off on the cylinder (tank) valve. Depressurize the system and correct any issues. After all corrections have been made, open the manual shut-off valve and start the engine. Run the leak test again.



Drive / Performance Test: All converted vehicles must go through a drive test. Test acceleration, idle, shifting, etc.. Any noticeable performance issues should be investigated and fixed prior to release.

Quality Control: Check overall condition of converted vehicle. Any damage to vehicle during install should be repaired prior to release to customer. Vehicle should be clean and have an OEM feel to the system installed.

Contact Information

Altech-Eco Corporation
101 Fair Oaks Road
Arden, North Carolina 28704

Main Phone: 828-654-8300

Technical Support:

Phone: 828-654-8300

Email: customerservice@altecheco.com